

GREBENASTE SKLOPKE 10-32A - OPĆE INFORMACIJE

SCHRACK-INFO

Grebenaste sklopke mogu se primijeniti za gotovo svaku potrebu, primjerice, kao motorne, glavne, upravljačke sklopke te kao prekidači instrumenata.

UGRADNJA

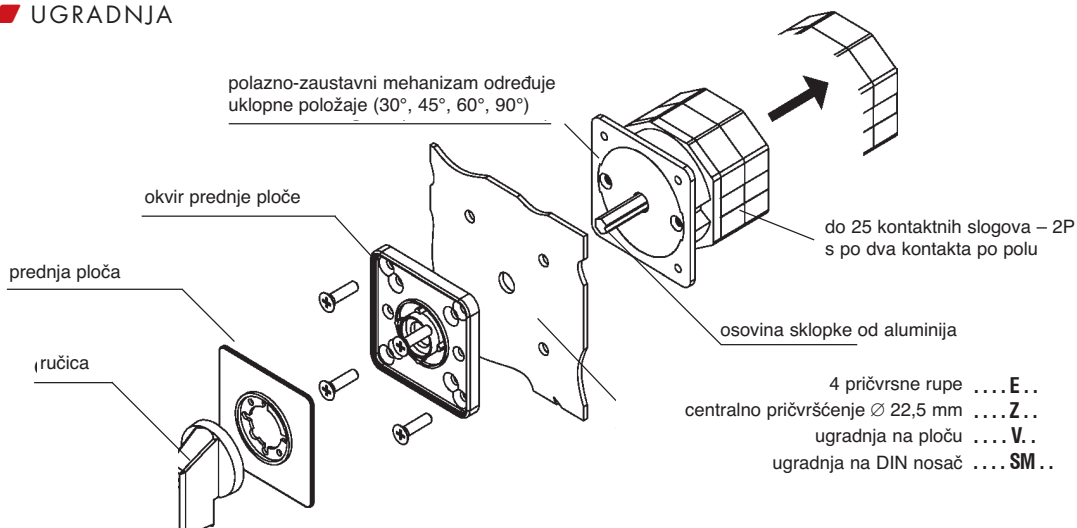

GREBENASTE SKLOPKE, UGRADNJA NA VRATA, UČVRŠĆENJE SA 4 VIJKA



IN005120

- SCHRACK-INFO
- za pričvršćenje na 4 mjesta
- prednje pričvršćenje
- isklopna moć: AC 3 do 15 kW
- nazivna struja: 20 A do 50 A
- tip E
- stupanj zaštite IP65

GREBENASTE SKLOPKE, UGRADNJA NA VRATA, **CENTRALNO UČVRŠĆENJE**



IN025120

- SCHRACK-INFO
- promjer 22 mm
- stupanj zaštite IP65

GREBENASTE SKLOPKE, **UGRADNJA NA DIN NOSAČ**



IN085220

- SCHRACK-INFO
- isklopna moć: do 11 kW
- nazivna struja: do 32 A
- tip: SMA
- stupanj zaštite IP40

GREBENASTE SKLOPKE **U KUĆIŠTU**



IN036120

- SCHRACK-INFO
- isklopna moć: AC 3 do 15 kW
- nazivna struja: do 32 A
- tip P (kućište od izolacijskog materijala) i G (oklopljeno kućište)
- stupanj zaštite IP40

MINI-GREBENASTE SKLOPKE, **CENTRALNO UČVRŠĆENJE**



IN626110

- SCHRACK-INFO
- promjer 16 mm i 22 mm
- stupanj zaštite IP65

GREBENASTE SKLOPKE 0-1, **UGRADNJA NA VRATA**, IP65 (IP40)



IN005120

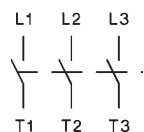

HEMA SPAJANJA

OPIS	TIP	EAN-KOD	RASPOLOŽIVOST	STORE	KAT. BR.
0-1/1P/20 A	M10H E A1	9004840040630			IN005120
0-1/2P/20 A	M10H E A2	9004840040647			IN005220
0-1/3P/20 A/5,5 kW	M10H E A3	9004840040654			IN005320
ON-OFF/1P/20 A	M10H E A1+003S	9004840110159			IN005121

GREBENASTA SKLOPKA 0-1, S KLJUČEM, **UGRADNJA NA VRATA**, IP65 (IP40)



IN005122

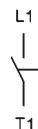

HEMA SPAJANJA

OPIS	TIP	EAN-KOD	RASPOLOŽIVOST	STORE	KAT. BR.
ON-OFF, s ključem/ 1P/20 A	M10H E A1+SA+002S+8100	9004840122619			IN005122

GREBENASTE SKLOPKE, 1-0-2, **UGRADNJA NA VRATA**, IP65 (IP40)



IN006320



IN006122

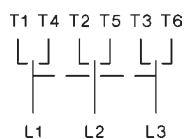

HEMA SPAJANJA

OPIS	TIP	EAN-KOD	RASPOLOŽIVOST	STORE	KAT. BR.
1-0-2/1P/20 A	M10H E U1	9004840040661			IN006120
1-0-2/2P/20 A	M10H E U2	9004840040678			IN006220
1-0-2/3P/20 A/5,5 kW	M10H E U3	9004840040685			IN006320
MAN-OFF-AUTO /1P/20 A	M10H E U1+088S	9004840110128			IN006121
HAND-0-AUTO /1P/20 A	M10H E U1+009S	9004840533217			IN006122
MAN-OFF-AUTO /2P/20 A	M10H E U2+088S	9004840110135			IN006221

GR. SKLOPKE, PREKLOPKE BEZ POLOŽAJA „0“, **UGRADNJA NA VRATA**, IP65 (IP40)



IN007122



IN007121

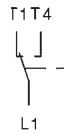

HEMA SPAJANJA

OPIS	TIP	EAN-KOD	RASPOLOŽIVOST	STORE	KAT. BR.
1-2/1P/20 A	M10H E W1	9004840122640			IN007122
HAND-AUTO /1P/20 A	M10H E W1+082S	9004840110142			IN007121

GR. SKLOPKA, ZVIJEZDA-TROKUT, **UGRADNJA NA VRATA**, IP65 (IP40)



IN108900

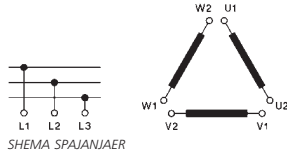

HEMA SPAJANJAER

OPIS	TIP	EAN-KOD	RASPOLOŽIVOST	STORE	KAT. BR.
zvezda-trokut sklopka, 32 A/15 kW	N20 E SD	9004840067828			IN108900

GR. SKLOPKA 1-0-2, PREKL. S POVRATOM U „0“, **UGR. NA VRATA**, IP65 (IP40)



IN004120



HEMA SPAJANJA

OPIS	TIP	EAN-KOD	RASPOLOŽIVOST	STORE	KAT. BR.
1-0-2, s povratom/1P/20 A	M10H E UR1	9004840122589			IN004120



NAVIGATOR ZNA NAJKRAĆI PUT! SA SCHRACK TECHNIK LIVE-PHONE APLIKACIJOM

- Tehnički podaci uvijek na raspolaganju
- Informacije o raspoloživosti i cijenama artikla
- Kupovina i narudžba artikala na dlanu

GREBENASTA SKLOPKA „START“, ZAKRETNO TIPKALO, **UGR. NA VRATA**, IP65



IN008120



HEMA SPAJANJA

OPIS	TIP	EAN-KOD	RASPOLOŽIVOST	STORE	KAT. BR.
zakretno tipkalo "START", 1P/20 A	M10H E SE	9004840122558			IN008120

VOLTMETARSKA PREKLOPKA, **UGRADNJA NA VRATA**, IP65



IN009V00

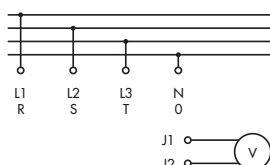

HEMA SPAJANJA

SCHRACK-INFO

3 linijska, 3 fazna napona

OPIS	TIP	EAN-KOD	RASPOLOŽIVOST	STORE	KAT. BR.
voltmetarska preklopka, 1P/20 A	M10H E V1+503	9004840110111			IN009V00

AMPERMETARSKA PREKLOPKA, **UGRADNJA NA VRATA**, IP65



IN009A00

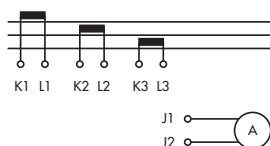

HEMA SPAJANJA

OPIS	TIP	EAN-KOD	RASPOLOŽIVOST	STORE	KAT. BR.
ampermetarska preklopka, 1P/20 A	M10H E M31+504	9004840110104			IN009A00



NAVIGATOR ZNA NAJKRAĆI PUT!

SCHRACK TECHNIK INTERNET TRGOVINA NA
WWW.SCHRACK.HR

- Lakše do informacija o proizvodima
- Kupovina 24/7
- Brzo do kontakt podatka Vašeg Schrack zastupnika

GREBENASTE SKLOPKE, STUPNJEVITE SKLOPKE 1- I 2-POLNE BEZ „0“, UGRADNJA NA VRATA, IP65



IN003121



IN003122

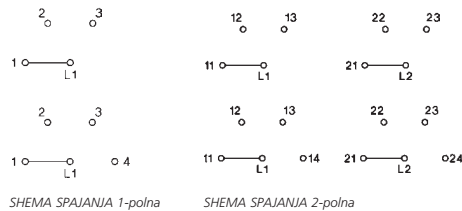

OPIS	TIP	EAN-KOD	RASPOLOŽIVOST	STORE	KAT. BR.
JEDNOPOLNE					
1-2-3/1P/20 A	M10H E ST31	9004840110166			IN003121
1-2-3-4/1P/20 A	M10H E ST41	9004840110173			IN003122
DVOPOLNE					
1-2-3/2P /20 A	M10H E ST32	9004840122565			IN003123
1-2-3-4/2P /20 A	M10H E ST42	9004840122572			IN003124
TROPOLNE					
1-2-3-4/3P /20 A	M10H E ST43	9004840653427			IN003125
ČETVEROPOLNE					
1-2-3-4/4P /20 A	M10H E ST44	9004840653434			IN003126

GREBENASTE SKLOPKE, 0-1, CENTRALNO UČVRŠĆENJE, Ø 22 mm, IP65



IN025120

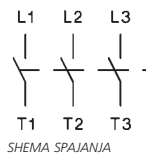

OPIS	TIP	EAN-KOD	RASPOLOŽIVOST	STORE	KAT. BR.
0-1/1P/20 A	M10H Z A1	9004840041071			IN025120
0-1/2P/20 A	M10H Z A2	9004840041088			IN025220
0-1/3P/20 A/5,5 kW	M10H Z A3	9004840041095			IN025320
0-1/3P/32 A/11 kW	M20 Z A3	9004840041699			IN125325



NAVIGATOR ZNA NAJKRAĆI PUT! SA SCHRACK TECHNIK LIVE-PHONE APLIKACIJOM

- Tehnički podaci uvijek na raspolaganju
- Informacije o raspoloživosti i cijenama artikla
- Kupovina i narudžba artikala na dlanu

GREBENASTE SKLOPKE 1-0-2, CENTRALNO UČVRŠĆENJE, Ø 22 mm, IP65



IN026220

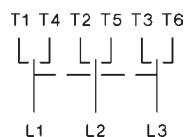

HEMA SPAJANJA

OPIS	TIP	EAN-KOD	RASPOLOŽIVOST	STORE	KAT. BR.
1-0-2/1P/20 A	M10H Z U1	9004840040975			IN026120
1-0-2/2P/20 A	M10H Z U2	9004840040814			IN026220
1-0-2/3P/20 A/5,5 kW	M10H Z U3	9004840040890			IN026320

GREBENASTE SKLOPKE 1-2, CENTRALNO UČVRŠĆENJE, Ø 22 mm, IP65



IN027220

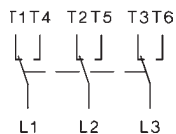

HEMA SPAJANJA

OPIS	TIP	EAN-KOD	RASPOLOŽIVOST	STORE	KAT. BR.
1-2/1P/20 A	M10H Z W1	9004840041019			IN027120
1-2/2P/20 A	M10H Z W2	9004840040777			IN027220
1-2/3P/20 A/5,5 kW	M10H Z W3	9004840041101			IN027320

GREBENASTA SKLOPKA, GRUPNA SKLOPKA, 1-POLNA, 2 GRUPE, CENTRALNO UČVRŠĆENJE, Ø 22 mm, IP65



IN020901

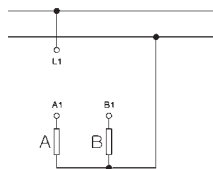

HEMA SPAJANJA

OPIS	TIP	EAN-KOD	RASPOLOŽIVOST	STORE	KAT. BR.
grupna sklopka, 1P/20 A	M10H Z GR11	9004840040692			IN020901

GREBENASTA SKLOPKA „START“, ZAKRETNO TIPKALO, CENTRALNO UČVRŠĆENJE, Ø 22 mm, IP65



INOZC102



HEMA SPAJANJA

OPIS	TIP	EAN-KOD	RASPOLOŽIVOST	STORE	KAT. BR.
zakretno tipkalo "start", 1P/20 A	M10H Z SE	9004840383881			INOZC102

VOLTMETARSKA PREKLOPKA, CENTRALNO UČVRŠĆENJE, Ø 22 mm, IP65



IN009V02

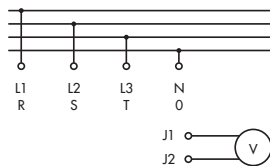

HEMA SPAJANJA

SCHRACK-INFO
3 linijska, 3 fazna napona

OPIS	TIP	EAN-KOD	RASPOLOŽIVOST	STORE	KAT. BR.
3 linijska i 3 fazna napona/20 A	M10H E V1	9004840223187			IN009V02

GREBENASTE SKLOPKE, STUPNJEVITE SKLOPKE, 1-POLNE BEZ „0“, CENTRALNO UČVRŠĆENJE, Ø 22 mm, IP65



INO23901



INO23902

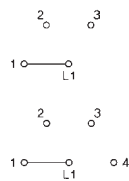

HEMA SPAJANJA 1-polig

OPIS	TIP	EAN-KOD	RASPOLOŽIVOST	STORE	KAT. BR.
1-2-3/1P/20 A	M10H Z ST31	9004840041040			INO23901
1-2-3-4/1P/20 A	M10H Z ST41	9004840041057			INO23902

GREBENASTE SKLOPKE, STUPNJEVITE SKLOPKE, 1-POLNE SA „0“, CENTRALNO UČVRŠĆENJE, Ø 22 mm, IP65



IN023903

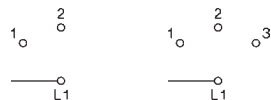

HEMA SPAJANJAER

OPIS	TIP	EAN-KOD	RASPOLOŽIVOST	STORE	KAT. BR.
0-1-2/1P/20 A	M10H Z ST021	9004840655049			IN023904
0-1-2-3/1P/20 A	M10H Z ST031	9004840041064			IN023903

PRIBOR ZA GREBENASTU SKLOPKU S CENTRALNIM UČVRŠĆENJEM



IN16001



IN16000

OPIS	TIP	EAN-KOD	RASPOLOŽIVOST	STORE	KAT. BR.
ručica, crna, za sklopku M10, M10H, M20	A1535	9004840106930			IN16001
ručica, plava za sklopku M10, M10H, M20	A1549	9004840106923			IN16000

GREBENASTE SKLOPKE 0-1, UGRADNJA NA DIN NOSAČ, IP40



IN085220

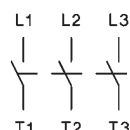

HEMA SPAJANJA

OPIS	TIP	EAN-KOD	RASPOLOŽIVOST	STORE	KAT. BR.
0-1/1P/20 A	M10H SMA A1	9004840041439			IN085120
0-1/2P/20 A	M10H SMA A2	9004840041446			IN085220
0-1/3P/20 A/5,5 kW	M10H SMA A3	9004840041453			IN085320

GREBENASTA SKLOPKA 0-1, S KLJUČEM, UGRADNJA NA DIN NOSAČ, IP40



IN085121

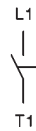

HEMA SPAJANJA

OPIS	TIP	EAN-KOD	RASPOLOŽIVOST	STORE	KAT. BR.
sklopka s ključem, 1P/20 A	M10H SMA A1+SA	9004840378931			IN085121

GREBENASTE SKLOPKE, 1-0-2, UGRADNJA NA DIN NOSAČ, IP40



IN086120



IN086121

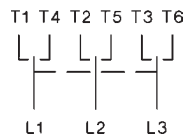

HEMA SPAJANJA

OPIS	TIP	EAN-KOD	RASPOLOŽIVOST	STORE	KAT. BR.
1-0-2/1P/20 A	M10H SMA U1	9004840041460			IN086120
1-0-2/2P/20 A	M10H SMA U2	9004840041477			IN086220
1-0-2/3P/20 A	M10H SMA U3	9004840041484			IN086320
HAND-0-AUTO /1P/20 A	M10H SMA U1+009S	9004840094268			IN086121
MAN-0-AUTO /1P/20 A	M10H SMA U1+081S	9004840094275			IN086122
TAG-0-NACHT/1P/20 A	M10H SMA U1+143S	9004840094282			IN086123

GREBENASTE SKL., PREKLOPKE BEZ POLOŽ. „0“, UGRADNJA NA DIN NOSAČ, IP40



IN087220

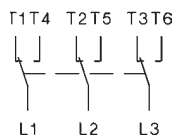

HEMA SPAJANJA

OPIS	TIP	EAN-KOD	RASPOLOŽIVOST	STORE	KAT. BR.
1-2/1P/20 A	M10H SMA W1	9004840041491			IN087120
1-2/2P/20 A	M10H SMA W2	9004840041507			IN087220
1-2/3P/20 A	M10H SMA W3	9004840041514			IN087320

VOLTMETARSKA PREKLOPKA, UGRADNJA NA DIN NOSAČ, IP40



IN009V01

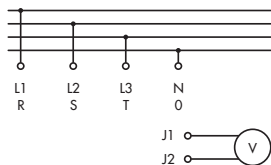

HEMA SPAJANJA

SCHRACK-INFO

3 linijska, 3 fazna napona

OPIS	TIP	EAN-KOD	RASPOLOŽIVOST	STORE	KAT. BR.
voltmetarska preklopka, 1P/20 A	M10H SMA V1	9004840164503			IN009V01

AMPERMETARSKA PREKLOPKA, UGRADNJA NA DIN NOSAČ, IP40



IN009A01

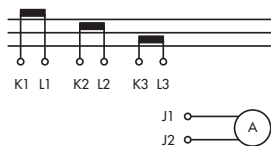

HEMA SPAJANJA

OPIS	TIP	EAN-KOD	RASPOLOŽIVOST	STORE	KAT. BR.
ampermetarska preklopka, 1P/20 A	M10H SMA M31	9004840164497			IN009A01

GREBENASTE SKLOPKE, STUPNJEVITE SKLOPKE 1- I 2-POLNE BEZ „0“ UGRADNJA NA DIN NOSAČ, IP40



IN083121



IN083220

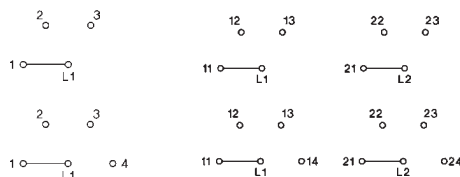

HEMA SPAJANJA 1-polna

HEMA SPAJANJA 2-polna

OPIS	TIP	EAN-KOD	RASPOLOŽIVOST	STORE	KAT. BR.
JEDNOPOLNE					
1-2-3/1P/20 A	M10H SMA ST31	9004840122602			IN083120
1-2-3-4/1P/20 A	M10H SMA ST41	9004840122626			IN083220
DVOPOLNE					
1-2-3/2P/20 A	M10H SMA ST32	9004840122596			IN083121
1-2-3-4/2P/20 A	M10H SMA ST42	9004840122633			IN083221

GREBENASTE SKLOPKE 0-1, U KUĆIŠTU, IP40



IN035220

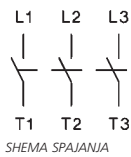

SCHRACK-INFO
u kućištu od izolacijskog materijala

OPIS	TIP	EAN-KOD	RASPOLOŽIVOST	STORE	KAT. BR.
0-1/1P/20 A	M10 P A1+K6	9004840041217			IN035120
0-1/2P/20 A	M10 P A2+K6	9004840040852			IN035220
0-1/3P/20 A/5,5 kW	M10 P A3+K6	9004840041224			IN035320
0-1/3P/32 A/11 kW	N20 P A3+K6	9004840041705			IN135325

GREBENASTA SKLOPKA 0-1, SKLOPKA GRIJANJA, 2-POLNA, U KUĆIŠTU, IP40



IN032009

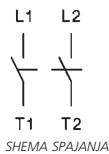

SCHRACK-INFO
u kućištu od izolacijskog materijala

OPIS	TIP	EAN-KOD	RASPOLOŽIVOST	STORE	KAT. BR.
0-1 sklopka grijanja/ 2P/20 A	M10 P A2+904465	9004840041200			IN032009

GREBENASTE SKLOPKE 1-0-2, U KUĆIŠTU, IP40



IN036320

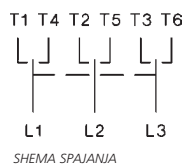

SCHRACK-INFO
u kućištu od izolacijskog materijala

OPIS	TIP	EAN-KOD	RASPOLOŽIVOST	STORE	KAT. BR.
1-0-2/1P/20 A	M10 P U1	9004840041231			IN036120
1-0-2/2P/20 A	M10 P U2	9004840041248			IN036220
1-0-2/3P/20 A/5,5 kW	M10 P U3	9004840041255			IN036320

MINI GREBENASTE SKLOPKE 0-1, CENTRALNO UČVRŠĆENJE, Ø 16 mm | Ø 22 mm, IP65



IN625210

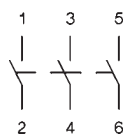

HEMA SPAJANJA

OPIS	TIP	EAN-KOD	RASPOLOŽIVOST	STORE	KAT. BR.
0-1/1P/20 A	M4H Z A1	9004840041934			IN625110
0-1/2P /20 A	M4H Z A2	9004840042061			IN625210
0-1/3P /20 A	M4H Z A3	9004840042078			IN625310

MINI GREBENASTE SKLOPKE 1-0-2, CENTRALNO UČVRŠĆENJE, Ø 16 mm | Ø 22 mm, IP65



IN0626310

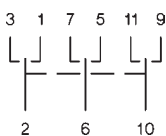

HEMA SPAJANJA

OPIS	TIP	EAN-KOD	RASPOLOŽIVOST	STORE	KAT. BR.
1-0-2/1P/10 A	M4H Z U1	9004840042085			IN626110
1-0-2/2P/10 A	M4H Z U2	9004840042092			IN626210
1-0-2/3P/10 A	M4H Z U3	9004840041972			IN626310

MINI GREBENASTE SKLOPKE 1-2, CENTRALNO UČVRŠĆENJE, Ø 16 mm | Ø 22 mm, IP65



IN0627210

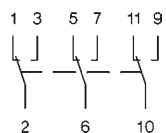

HEMA SPAJANJA

OPIS	TIP	EAN-KOD	RASPOLOŽIVOST	STORE	KAT. BR.
1-2/1P/10 A	M4H Z W1	9004840042108			IN627110
1-2/2P/10 A	M4H Z W2	9004840042115			IN627210
1-2/3P/10 A	M4H Z W3	9004840042122			IN627310

MINI GREBENASTA SKLOPKA, GRUPNA SKLOPKA 1-POLNA, 2 GRUPE, **CENTRALNO UČVRŠĆENJE**, Ø 16 mm | Ø 22 mm, IP65



IN620901

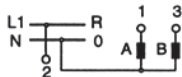

HEMA SPAJANJA

OPIS	TIP	EAN-KOD	RASPOLOŽIVOST	STORE	KAT. BR.
grupna sklopka, 1P/10 A	M4H Z GR11	9004840041866			IN620901

MINI GREBENASTA SKLOPKA, STUPNJEVITA SKLOPKA 1-POLNA BEZ „0“, **CENTRALNO UČVRŠĆENJE**, Ø 16 mm | Ø 22 mm, IP65



IN623901

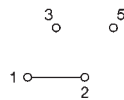

HEMA SPAJANJA

OPIS	TIP	EAN-KOD	RASPOLOŽIVOST	STORE	KAT. BR.
1-2-3/1P/10 A	M4H Z ST31	9004840042030			IN623901

MINI GREBENASTE SKLOPKE, STUPNJEVITE SKLOPKE 1-POLNE SA „0“, **CENTRALNO UČVRŠĆENJE**, Ø 16 mm | Ø 22 mm, IP65



IN623902



IN623903

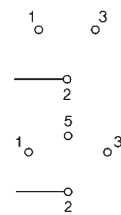

HEMA SPAJANJA

OPIS	TIP	EAN-KOD	RASPOLOŽIVOST	STORE	KAT. BR.
0-1-2/1P/10 A	M4H Z ST021	9004840042047			IN623902
0-1-2-3/1P/10 A	M4H Z ST031	9004840042054			IN623903

GREBENASTE SKLOPKE - TEHNIČKI PODACI

Podaci prema IEC 947-3, IEC 947-5-1, VDE 0660, EN 60947-3, EN 60947-5-1, SEV, CEE24

Tip	M10	M10H	M20
term. nazivna struja I_{th} otvoreno	20	20	32
term. nazivna struja I_{the} u kućištu	20	20	32
nazivni pogonski napon U_e uvjeti isklopa ²⁾	V 440	690 ¹⁾	690 ¹⁾
prema VDE, IEC ispunjeni do	V 440	440	440
isklopna moć I_{eff}			
3x220-440 V A	160	160	220
3x500 V A	-	100	160
3x660-690 V A	80	120	120
kategorija uporabe AC21A, AC21B preklapanje omskih tereta uključujući i niže preopterećenje			
nazivna pogonska struja I_e	20	20	32
kategorija uporabe AC23A, AC23B uklop motora i ostalih visokoinduktivnih tereta			
nazivna pogonska struja I_e 400 V A	16	16	30
nazivna snaga 220-240 V kW	4	4	7,5
3-fazna 3-polna 380-440 V kW	7,5	7,5	15
500 V kW	-	7,5	15
660-690 V kW	-	7,5	15
sklopka zvijezda-trokut za kavezne motore			
nazivna snaga			
3-fazna 3-polna 220-240 V A	3,7	3,7	7,5
380-415 V A	7,5	7,5	15
kategorija uporabe AC3 kavezni mot.: pokretanje, isklj.			
nazivna pogonska struja I_e 400 V A	12	12	22
nazivna snaga 220-240 V kW	3	3	5,5
3-fazna 3-polna 380-440 V kW	5,5	5,5	11
500 V kW	-	5,5	11
660-690 V kW	-	5,5	11
kategorija uporabe AC4 kavezni mot.: pokretanje, reverz.			
nazivna snaga 220-240 V kW	0,55	0,55	2,2
3-fazna 3-polna 380-440 V kW	1,5	1,5	4
500 V kW	-	1,5	4
660-690 V kW	-	1,5	4
kategorija uporabe AC15 elektromagneti za sklopnike i ventile te drugi magneti			
nazivna pogonska struja I_e			
do 240 V A	6	6	12
380-440 V A	4	4	6
2-polno isklapanje 500 V A	-	5	8
kategorija uporabe DC21A, DC21B uklop omskih tereta uključujući i manje preopterećenje, L/R≤1ms			
nazivna pogonska struja I_e			
1-polna 30 V A	20	20	32
60 V A	4	4	6
110 V A	0,6	0,6	3
220 V A	0,3	0,3	0,8
440 V A	-	-	0,4
kategorija uporabe DC3 - DC5 serijski i paralelni motori vremenska konstanta L/R≤15ms			
nazivna pogonska struja I_e			
1-polna 30 V A	8	8	13
60 V A	1	1	2,4
110 V A	0,3	0,3	0,5
stupanj zaštite, stražnja strana	IP00	IP20	IP00

1) vrijedi za: mreže s uzemljenom neutralnom točkom, kategorije prenapona I do III, stupanj zagađenja 3: $U_{imp} = 6kV$; vrijednosti za druge uvjete na upit.

2) uvjeti rastavljača prema IEC 947-1 i VDE 0660 vrijede za: mreže s uzemljenom neutralnom točkom, kategorije prenapona III i nehomogenim poljem.

GREBENASTE SKLOPKE - TEHNIČKI PODACI

Podaci prema IEC 947-3, IEC 947-5-1, VDE 0660, EN 60947-3, EN 60947-5-1

Tip		M10 P	M10H	M20	
presjek priključnih vodiča					
jednožilni odn. višezilni	mm ²	1-2,5	1-2,5 ¹⁾	1,5-6	
finožičani	mm ²	0,75-2,5	0,75-2,5 ¹⁾	1-4	
finožičani s kabelskim završetkom	mm ²	0,75-2,5	0,75-1,5	1-4	
vodova po stezaljci		2	2	2	
vijci stezaljki		M3	M3,5	M4	
moment pritezanja	Nm lb/inch	0,6-1,2 5-11	0,8-1,4 7-12	1,2-1,8 11-16	
zaštita od kratkog spoja					
maks. osigurač gL (gG)	A	20	20	35	
nazivna otpornost na kratkotrajnu udarnu struju (struja u 1 sek.)	A	250	250	400	
uvjetna nazivna struja kratkog spoja	A	10	10	10	
kratkotrajna opteretivost					
trajanje opterećenja	3s	A	100	100	200
	10s	A	60	60	130
vrijednosti primjenjive	30s	A	35	35	85
za zatvorene kontakte	60s	A	25	25	65
disipacija snage kod AC21A					
po polu	A W	20 0,6	20 0,5	32 0,9	
Uklop kapacitivnih tereta					
maks. uklopna moć do 500 V	A	140	140	300	

Podaci prema UL i cUL

Tip			M10 P	M10H	M20
nazivni pogonski napon		V-	300	600	600
nazivna pogonska struja	"General use" s jumperom	A	20	20	35
		A	15	-	25
DOL- 3-fazno	110-120V	hp	1½	1½	5
	200-208V	hp	2	2	5
	220-240V	hp	3	3	5
	440-480V	hp	-	5	10
	550-600V	hp	-	7½	15
	DOL- 1-fazno	110-120V	hp	½	½
	200-208V	hp	1	1	3
	220-240V	hp	1½	1½	5
veličina osigurača (RK5) 5 kA/600 V	ručni motor kontroler i isključivanje motora	A	40 ²⁾	40	80
heavy pilot duty		AC	A300	A600	A600
presjek priključnih vodiča					
jednožilni		AWG	12 - 20	12 - 20	10 - 18
finožičani		AWG	14 - 20	14 - 20	8 - 18
moment pritezanja		Nm lb/inch	1.7 15	1-1.7 9-15	1.7-2.8 15-25

1) maksimalni presjek priključnih vodiča

2) 5kA / 300V

GREBENASTA SKLOPKA - DIMENZIJE

UGRADNJA NA VRATA

grebena sklopka za ugradnju na vrata
M10H E

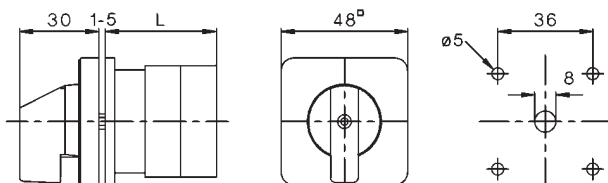

ZA CENTRALNO UČVRŠĆENJE

grebena sklopka za centralno učvršćenje
M10H Z., M20 Z..

M4H Z..

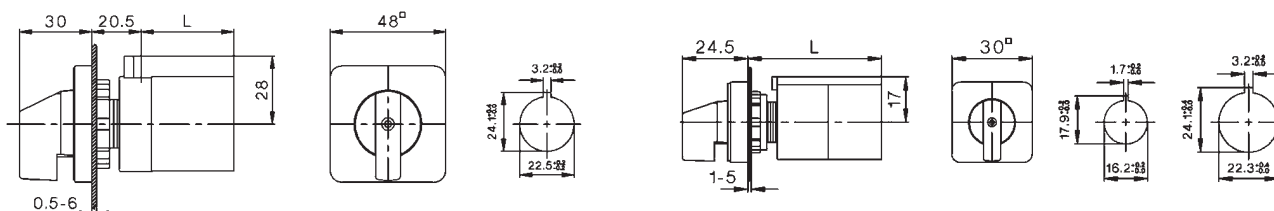

dimenzija L kod sklopki

sklopka	A1, A2, U1, W1, UR1, SE, SA, GR11, ST021 1 kontaktni slog	A3, U2, W2 ST31, ST41, ST031 2 kontaktna sloga	U3, W3 V1, M31, ST32 3 kontaktna sloga	ST42 4 kontaktna sloga
M4H	51	62,5	74,5	86,5
M10H	36,5	46	55,5	65
M20	38,5	51	63,5	76

UGRADNJA NA DIN NOSAČ

Grebenaste sklopke za ugradnju na DIN nosač

M10H SMA.. 1-3 kontaktna sloga
M20 SMA.. 1,2 kontaktna sloga

Sklopke s ključem za redna ugradnja

Tip	dimenzija X kod kontaktna sloga				dimenzija Y kod kontaktna sloga		
	1	2	3	4	1	2	3
M10H	44	75	75	91	60	90	90
M20	59	75	75	91	75	90	90

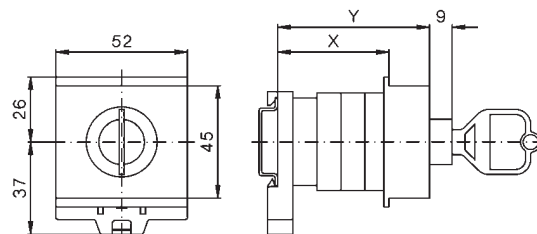
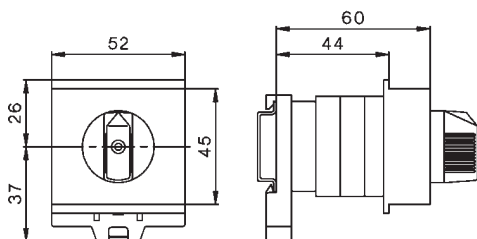

GREBENASTA SKLOPKA - DIMENZIJE

U KUĆIŠTU OD IZOLACIJSKOG MATERIJALA

sklopka u kućištu od izolacijskog materijala
M10P.

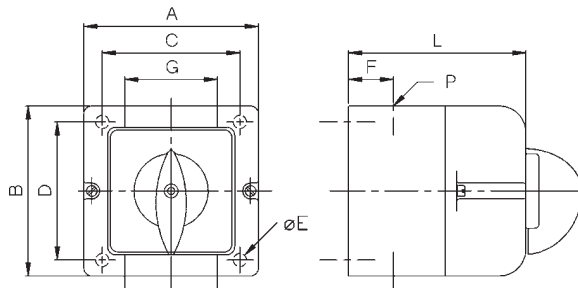

Tip	A	B	C	D	E	F	G	P	dimenzija L kod ... kontaktna sloga			
									1	2	3	4
M10	66	64	50	36	5	15,5	26	M20	43	52	62	71

GREBENASTA SKLOPKA SERIJE KN - PREGLED IZVEDBENIH OBLIKA

CG4 FS2, UGRADNJA NA VRATA, CENTRALNO UČVRŠĆENJE



CG4 FS2

SCHRACK-INFO

- za centralno pričvršćivanje
- stupanj zaštite IP66

CH10 600E, UGRADNJA NA VRATA, UČVRŠĆENJE SA 4 VIJKA



CH10 600E

SCHRACK-INFO

- za pričvršćenje na 4 mjesta
- stupanj zaštite IP40

CH10 FT2, UGRADNJA NA VRATA, CENTRALNO UČVRŠĆENJE



CH10 FT2

SCHRACK-INFO

- za centralno pričvršćivanje
- stupanj zaštite IP66

CG8 VE21, UGRADNJA NA DIN NOSAČ



CG8 VE21

SCHRACK-INFO

- sklopka za ugradnju na DIN nosač
- uskočno pričvršćivanje na standardnu šinu prema EN 50022
- s prednjom pločom za otvor od 45 mm
- stupanj zaštite IP40

CA10 PNL, U KUĆIŠTU



CA10 PNL

SCHRACK-INFO

- sklopke u plastičnim kućištima
- stupanj zaštite: IP42

GREBENASTE SKLOPKE SERIJE KN - TEHNIČKI PODACI

tehnički podaci prema VDE	CG4	CG8	CA10 / CH10	
term. nazivna struja Ith A	A	10	20	20
AC3 pri 3 x 400 V kW	kW	2,2	5,5	5,5
AC15 pri 230 V A	A	2,5	5,0	5,0
maks. presjek priključnih vodiča	mm ²	1,5	2,5	2,5
modularnih širina (ŠM)		2	3	3

GREBENASTA SKLOPKA SERIJE KN - DIMENZIJE

Ugradnja na vrata s pričvršćivanjem pomoću dvije odn. 4 rupe, stupanj zaštite IP40

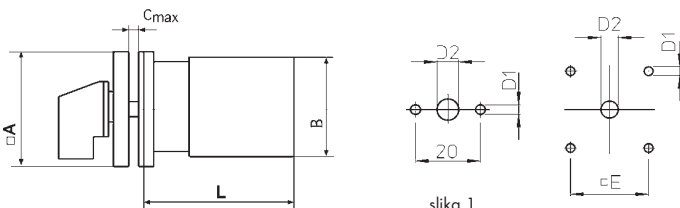

	A	B	C _{max}	D1	D2	E	slika
CA4	30	28	4	3,2	8	-	1
CA10	48	43	4	5	8	36	2
CG4	30	28	4	3,2	8	-	1
CG8	48	38	4	5	8	36	2
CH10	48	46	4	5	8	36	2

dimenzija L vidi tabelu „ugradna dubina L za ugradnju na vrata“!

prednja ugradnja s centralnim pričvršćivanjem, stupanj zaštite IP66

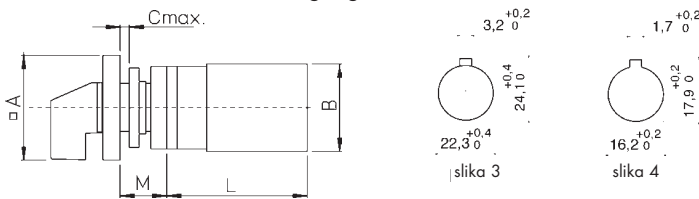

	A	B	C _{max}	M	slika
CA4	30	28	4	12,5 3 od.4	
CA10	48	43	4	18,2 3	
CG4	30	28	4	12,5 3 od.4	
CG8	48	38	4	18,2 3	
CH10	48	46	4	18,2 3	

dimenzija L vidi tabelu „ugradna dubina L za ugradnju na vrata“!

program	elemenata	program	elemenata	program	elemenata
A007	3	A210	1	A228	3
A174	1	A211	2	A400	2
A175	1	A212	3	A401	3
A176	1	A213	4	A410	4
A178	1	A214	1	A413	5
A200	1	A215	2	A440	4
A201	1	A216	3	A441	4
A202	2	A220	1		
A203	2	A221	2		
A204	1	A222	3		
A205	1				
A206	2				

ugradna dubina L za ugradnju na vrata

elemenata	1	2	3	4
CA4	30	38	46	54
CA10	33,5	43	52,5	62
CG4	38,5	50,5	62,5	74,5
CG8	40,7	53,4	66,1	78,8
CH10	43,5	57,5	71,5	85,5

U kućištu, PNL1, PFL1, PNL4, PFL4 (pogon sprijeda)

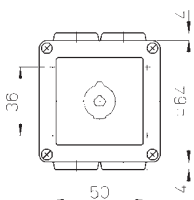

CA10

tip sklopke	broj elemen.	IP42		PNL1, PFL1 PNL4, PFL4 uvod kabla sa 4 x M
		C	C	
CA10	1	36,3	41,3	20
CA10	2	45,8	50,8	20
CA10	3	55,3	60,3	20
CA10	4	64,8	69,8	20

GREBENASTE SKLOPKE

GREBENASTE SKLOPKE 0-1, UGRADNJA NA VRATA, IP40



IN002000



HEMA

SCHRACK-INFO

- izvedba CH10
- učvršćenje s 4 šarafa

OPIS	EAN KOD	RASPOLOŽIVOST	STORE	KAT. BR.
1P/20 A, A200-600E isklonik	9004257022793			IN002000
2P/20 A, A201-600E isklonik	9004257022809			IN002001
3P/20 A, A202-600E isklonik	9004257022816			IN002002

GREBENASTE SKLOPKE, 1-0-2, UGRADNJA NA VRATA, IP40



IN002108



IN002117

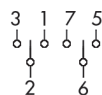

HEMA

SCHRACK-INFO

- izvedba CH10
- učvršćenje s 4 šarafa

OPIS	EAN KOD	RASPOLOŽIVOST	STORE	KAT. BR.
1-0-2/1P/20 A, A210-600E	9004257022854			IN002108
1-0-2/2P/20 A, A211-600E	9004257022861			IN002109
HAND-0-AUTO/2P/20 A, A212-600E	9004840086898			IN002117

GREBENASTA SKLOPKA „START“, ZAKRETNO TIPKALO, UGRADNJA NA VRATA, IP40



IN002004

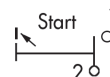

HEMA

SCHRACK-INFO

- izvedba CH10
- učvršćenje s 4 šarafa

OPIS	EAN KOD	RASPOLOŽIVOST	STORE	KAT. BR.
zakretno tipkalo "START", 1P/20 A, AC21, A1 75-600E, on-tipkalo	9004257054404			IN002004

VOLTMETARSKA PREKLOPKA, UGRADNJA NA VRATA, IP40



IN002014

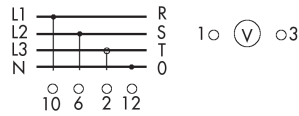

SHEMA

SCHRACK-INFO

- izvedba CH10
- učvršćenje s 4 šarafa

OPIS	EAN KOD	RASPOLOŽIVOST	STORE	KAT. BR.
Voltmetarska preklopka, 1P/20 A, A007-624E	9004257063208			IN002014

GREBENASTE SKLOPKE, 0-1, CENTRALNO UČVRŠĆENJE, Ø 22 MM, IP66



IN022000

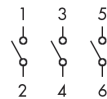

SHEMA

SCHRACK-INFO

- izvedba CH10

OPIS	EAN KOD	RASPOLOŽIVOST	STORE	KAT. BR.
0-1/1P/20 A, A200-600FT2	9004257022175			IN022000
0-1/2P/20 A, A20-600FT2	9004257022182			IN022001
0-1/3P/20 A/5,5 kW, A202-600FT2	9004257022199			IN022002

GREBENASTE SKLOPKE 1-0-2, CENTRALNO UČVRŠĆENJE, Ø 22 MM, IP66



IN022003

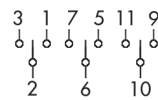

SHEMA

SCHRACK-INFO

- verzija CH10

OPIS	EAN KOD	RASPOLOŽIVOST	STORE	KAT. BR.
1-0-2/1P /20 A, A210-600FT2	9004257022236			IN022003
1-0-2/2P/20 A, A211-600FT2	9004257022243			IN022004
1-0-2/3P/20 A/5,5 kW, A212-600FT2	9004257022250			IN022005

GREBENASTE SKLOPKE

GREBENASTE SKLOPKE 1-2, **CENTRALNO UČVRŠĆENJE**, Ø 22 MM, IP66



IN022006

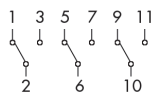

SHEMA

SCHRACK-INFO
• Izvedba CH10

OPIS	EAN KOD	RASPOLOŽIVOST	STORE	KAT. BR.
1-2/1P/20 A/1 -2, A220-600FT2	9004257056873			IN022006
1-2/2P/20 A/1 -2, A221-600FT2	9004257056880			IN022007
1-2/3P/20 A/5,5 kW/1-2, A222-600FT2	9004257056897			IN022008

GREBENASTA SKLOPKA „START“, ZAKRETNO TIPKALO, **CENTRALNO UČVRŠĆENJE**, Ø 22 MM, IP66



IN021001

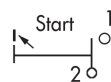

SHEMA

SCHRACK-INFO
• Izvedba CH10

OPIS	EAN KOD	RASPOLOŽIVOST	STORE	KAT. BR.
zakretno tipkalo "start", 1P/20 A, AC21, A175-600FT2, on-tipkalo	9004257056798			IN021001

GREBENASTE SKLOPKE, STUPNJEVITE SKLOPKE, 1-POLNE BEZ „0“, **CENTRALNO UČVRŠĆENJE**, Ø 22 MM, IP66



IN022009

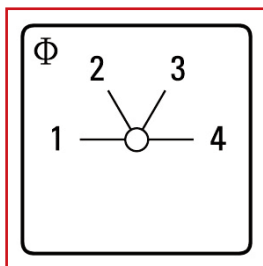

IN022017

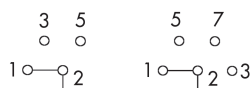

SHEMA

SCHRACK-INFO
• Izvedba CH10

OPIS	EAN KOD	RASPOLOŽIVOST	STORE	KAT. BR.
1-2-3/1P/20 A, A230-600FT2	9004257056927			IN022009
1-2-3-4/1P/20 A /20 A, A231-600FT2	9004257056934			IN022017

GREBENASTA SKLOPKA, STUPNJEVITA SKLOPKA, 1-POLNA SA „0“, CENTRALNO UČVRŠĆENJE, Ø 22 MM, IP66



IN022011



HEMA

SCHRACK-INFO

- Izvedba CH10

OPIS	EAN KOD	RASPOLOŽIVOST	STORE	KAT. BR.
0-1-2-3/1P/20 A, A241-600FT2	9004257022298			IN022011

GREBENASTE SKLOPKE 0-1, UGRADNJA NA DIN NOSAČ, IP40



IN082000

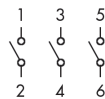

HEMA

SCHRACK-INFO

- Izvedba CG8 VE21

OPIS	EAN KOD	RASPOLOŽIVOST	STORE	KAT. BR.
0-1/1P/20 A/-, A200VE21	9004257022380			IN082000
0-1/2P/20 A/-, A201VE21	9004257022397			IN082001
0-1/3P/20 A/5,5 kW/-, A202VE21	9004257022403			IN082002

GREBENASTE SKLOPKE, 1-0-2, UGRADNJA NA DIN NOSAČ, IP40



IN082003



IN082009

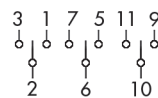

HEMA

SCHRACK-INFO

- Izvedba CG8 VE21

OPIS	EAN KOD	RASPOLOŽIVOST	STORE	KAT. BR.
1-0-2/1P/20 A, A210VE21	9004257022410			IN082003
1-0-2/2P/20 A, A211VE21	9004257022427			IN082004
1-0-2/3P/20 A, A212/A-0010*VE21	9004257022434			IN082005
HAND-0-AUTO /1P/20 A, A210VE21 F086	9004840086867			IN082009

GREBENASTE SKLOPKE

GREBENASTE SKLOPKE, PREKLOPKE BEZ POLOŽAJA „0“, **UGRADNJA NA DIN NOSAČ, IP40**



IN082006

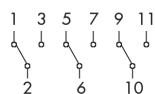

SCHEMA

- SCHRACK-INFO
- Izvedba CG8 VE21

OPIS	EAN KOD	RASPOLOŽIVOST	STORE	KAT. BR.
1-2/1P/20 A, A220VE21	9004257058112			IN082006
1-2/2P/20 A, A221VE21	9004257058129			IN082007
1-2/3P/20 A/5,5 kW, A222VE21	9004257058136			IN082008

GREBENASTE SKLOPKE 0-1, **U KUĆIŠTU, IP42**



IN032000



SCHEMA

- SCHRACK-INFO
- Izvedba CH10
- u kućištu od izolacijskog materijala

OPIS	EAN KOD	RASPOLOŽIVOST	STORE	KAT. BR.
0-1/1P/20 A/-, A200PNL1	9004257051465			IN032000
0-1/2P/20 A/-, A201PNL1	9004257051472			IN032001
0-1/3P/20 A/5,5 kW/-, A202PNL1	9004257051489			IN032002

GREBENASTE SKLOPKE 1-0-2, **U KUĆIŠTU, IP40**



IN032003

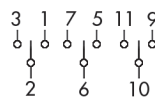

SCHEMA SPAJANJA

- SCHRACK-INFO
- Izvedba CH10
- u kućištu od izolacijskog materijala
- 4 x ulaznice M20

OPIS	EAN KOD	RASPOLOŽIVOST	STORE	KAT. BR.
1-0-2/1P/20 A/-, A200PNL1	9004257051540			IN032003
1-0-2/2P/20 A/-, A201PNL1	9004257051557			IN032004
1-0-2/3P/20 A/5,5 kW/-, A202PNL1	9004257051564			IN032005

MINI GREBENASTE SKLOPKE 0-1, **CENTRALNO UČVRŠĆENJE**, Ø 16 MM I Ø 22 MM, IP66



IN622000

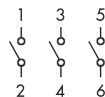

SCHEMA

SCHRACK-INFO

- Izvedba CG4

OPIS	EAN KOD	RASPOLOŽIVOST	STORE	KAT. BR.
0-1/1P/10 A, A200-600FS2	9004257021574			IN622000
0-1/2P/10 A, A201-600FS2	9004257021581			IN622001
0-1/3P/10 A/5,5 kW, A202-600FT2	9004257021598			IN622002

MINI GREBENASTE SKLOPKE 1-0-2, **CENTRALNO UČVRŠĆENJE**, Ø 16 MM I Ø 22 MM, IP66



IN622003

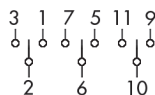

SCHEMA

SCHRACK-INFO

- Izvedba CG4

OPIS	EAN KOD	RASPOLOŽIVOST	STORE	KAT. BR.
1-0-2/1P/10 A, A210-600FS2	9004257021635			IN622003
1-0-2/2P/10 A, A211-600FS2	9004257021642			IN622004
1-0-2/1P/10 A, A212-600FS2	9004257021659			IN622005

MINI GREBENASTE SKLOPKE 1-2, **CENTRALNO UČVRŠĆENJE**, Ø 16 MM I Ø 22 MM, IP66



IN082006

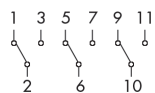

SCHEMA

SCHRACK-INFO

- Izvedba CG4

OPIS	EAN KOD	RASPOLOŽIVOST	STORE	KAT. BR.
1-2/1P/20 A, A220-600FS2	9004257056026			IN622006
1-2/2P/20 A, A221-600FS2	9004257056033			IN622007
1-2/3P/20 A, A222-600FS2	9004257056040			IN622008