

# Weather compensated controllers

## WDC10B | WDC10 | WDC20

### Presentation



WDC weather compensated controllers are intended for the control of room heating and domestic hot water heating in single-family houses.

They provide the control of one or two heating circuits, switchover between heat sources, and the protection of the return line during the storage tank loading.

They are used for heating systems with one or two boilers, a heat pump, a storage tank, and a solar system.

#### Typical application

- Radiator room heating system control.
- Floor heating or cooling system control.
- Convector heating or cooling system control.
- Wall or ceiling heating or cooling system control.
- Domestic hot water heating.

#### Features

- Up to 52 preset hydraulic schemes.
- Room heating or cooling according to the time programme.
- Domestic hot water heating according to the time programme.
- Solar system domestic hot water heating.
- Control of heating systems with a storage tank.
- The possibility of connecting 2 room units.
- BOOST function for intense room heating.
- Integrated solar system protection features.
- 13-language user interface.
- Wizard for an easy and quick device start-up.
- Notifications on the activated protection functions and warnings about system failures.
- Possibility to simulate sensors and analyse the system operation.
- Remote control with the help of the SeltronHome system.

### Description of settings buttons

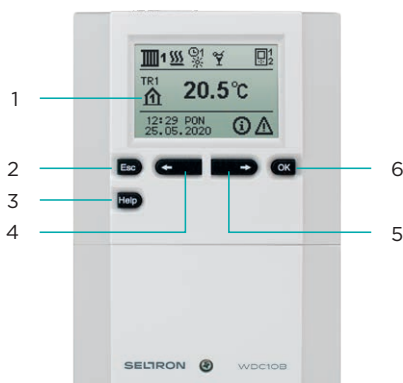

- 1 - Graphic display.
- 2 - **Esc** Move backwards key.
- 3 - **Help** Help key.
- 4 - **←** Move left or reduction key.
- 5 - **→** Move right or increase key.
- 6 - **OK** Menu entry or selection confirmation key.

Typical application	WDC10B	WDC10	WDC20
Radiator room heating system control	•	•	•
Floor heating or cooling system control	•	•	•
Convactor heating or cooling system control	•	•	•
Wall or ceiling heating or cooling system control	•	•	•
Domestic hot water heating	•	•	•
<b>Technical characteristics</b>			
No. of preset hydraulic schemes	7	17	52
No. of room units	2	2	2
No. of mechanical relays	6	6	7
No. of solid state relays	—	1	1
No. of analogue outputs (0÷10 V or PWM) for the control of the circulation pump or an energy source	2	2	2
No. of temperature sensor inputs	7	7	7
BUS option - the interconnection of WDC controllers and connection with other Seltron controllers	•	•	•
<b>System control</b>			
Control of a heating system with radiators	•	•	•
Floor heating or cooling system control	•	•	•
Convactor heating or cooling system control	•	•	•
Wall or ceiling heating or cooling system control	•	•	•
Domestic hot water heating system control	•	•	•
<b>Heating circuits control</b>			
Direct circuit	•	•	•
Mixing circuit	•	•	•
Direct and mixing circuit	—	•	•
Two mixing circuits	—	—	•
Domestic hot water heating	•	•	•
Switchover between direct heating circuit and domestic hot water heating	•	•	•
Domestic hot water circulation	•	•	•
Automatic switchover between heat sources	—	—	•
Control of the supply line constant temperature	•	•	•
Single-stage storage tank loading	—	—	•
<b>Heat source control</b>			
Solid fuel boiler	•	•	•
Solid fuel boiler with a pellet burner	—	—	•
Liquid fuel boiler	•	•	•
Liquid fuel boiler with a two-stage burner	•	•	•
Combined boiler	—	—	•
Gas flow boiler	—	—	•
Heat pump	—	—	•
Storage tank	•	•	•
Auxiliary heating with electricity	•	•	•
Solar collectors	—	•	•
<b>Domestic hot water heating</b>			
With a primary heating source	•	•	•
With a storage tank	•	•	•
Using a solar system	—	•	•
<b>User functions</b>			
Room heating or cooling according to the time programme	•	•	•
Automatic winter/summer mode switchover	•	•	•
PARTY function - activation of the comfort operation mode	•	•	•
ECO function - activation of the economy operation mode	•	•	•
HOLIDAY function - activation of the operation mode during the holiday season	•	•	•
Domestic hot water heating according to the time programme	•	•	•
One-time domestic hot water heating	•	•	•
BOOST function for intense room heating	•	•	•
Function for screed drying	•	•	•

Heating system protection	WDC10B	WDC10	WDC20
Anti-legionella protection (for a controlled energy source)	●	●	●
Storage tank overheating protection	●	●	●
Boiler overheating protection	●	●	●
Collector frost protection	—	●	●
Forced pump start at the highest collector temperature	—	●	●
Switching off of the collectors when the safety temperature has been exceeded	—	●	●
Solar system protection when collectors are overheating	—	●	●
Storage tank recooling to the desired temperature	—	●	●
Periodic starting up of pumps and mixing valves during a period of inactivity	●	●	●
A comprehensive overview of the heating system operation			
Graphic display of temperatures according to days of the last week	●	●	●
Detailed display of temperatures for the current day	●	●	●
Notifications on the activated protection functions and warnings about system failures	●	●	●
Possibility to simulate sensors and analyse the system operation	●	●	●
Remote access			
With a separate dedicated cable, the controller can be connected to a computer	●	●	●
Connectivity to the SeltronHome platform providing remote control using a smartphone or tablet	●	●	●
Setup and installation			
Wizard for an easy and quick device start-up	●	●	●
13-language user interface: EN, DE, FR, NL, PL, ES, SL, IT, CS, LT, GR, HU, HR	●	●	●
Setting up the operation by selecting the hydraulic scheme	●	●	●
“Help” button for quick help with the setup	●	●	●
Graphically adjustable time programmes	●	●	●
Option to simulate the system operation	●	●	●
Logging and display of changes made to the setup	●	●	●
Option for retrieval of the basic setup in the event of data loss or unwanted changes	●	●	●
Option for programming free outputs	●	●	●
Possibility of wall or DIN rail installation	●	●	●
Simple installation and connection	●	●	●

## Outlined functions



Step 1

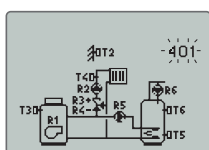

Step 2

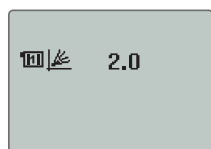

Steps 3 and 4

### Start-up wizard

The WDC controller is equipped with a start-up wizard, which takes you through the initial setup of the controller in 3 or 4 steps.

**Step 1:** language selection.

**Step 2:** hydraulic scheme selection.

**Step 3:** setting the heating curve for the first heating circuit.

**Step 4:** setting the heating curve for the second heating circuit.

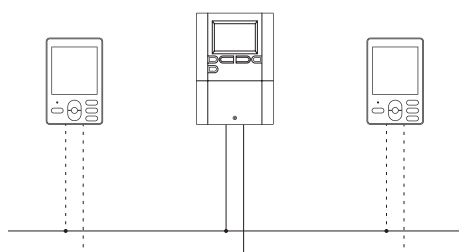

### Possibility to connect a Seltron room unit

The WDC controller provides the connection of RCD room units. The room unit provides measurements of room temperature, selection of operation mode and setting of daytime and nighttime temperatures. Up to two room units may be connected to one WDC controller.

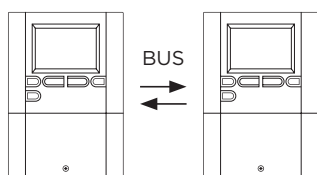

### BUS connection of multiple controllers

A random number of WDC controllers can be interconnected with the BUS connection. The master controller controls heat sources and heating circuits, meanwhile the slave controllers only control heating circuits. The outdoor sensor and the boiler temperature sensor are connected to the master controller.

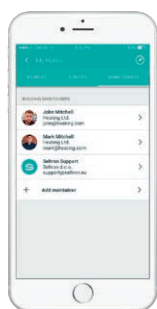

### Remote control with the help of SeltronHome system

The WDC controllers may be connected to the SeltronHome platform, which provides the heating remote control using a smartphone or tablet. Remote control is enabled through the CLAUSIUS application for the end user and the KELVIN app for service technicians. The CLAUSIUS application provides the adaptation of the heating to our lifestyle, which leads to greater comfort and reduced heating expenses.

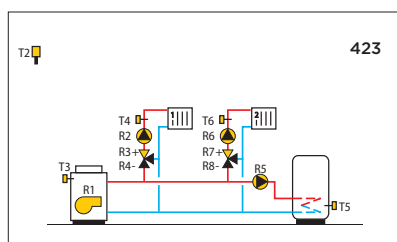

### Typical hydraulic scheme

Oil boiler, 2 mixing circuits, domestic hot water storage tank.

Example: hydraulic scheme 423.

Technical specifications	WDC10B	WDC10	WDC20
Backlit graphic display	•	•	•
Operating hours meter	•	•	•
Weekly program timer	•	•	•
Connection voltage	230 V-, 50 Hz		
Own consumption	2.5 W		
Energy consumption in the standby mode	Max. 0.5 W		
No. of inputs	7 pcs temperature sensor (Pt 1000)		
No. of outputs	6 pcs mechanical 2 pcs PWM or analogue 0÷10 V (Y2)	6 pcs mechanical 1 pc electronic 2 pcs PWM or analogue 0÷10 V (Y1, Y2)	7 pcs mechanical 1 pc electronic 2 pcs PWM or analogue 0÷10 V (Y1, Y2)
Relay outputs	4 (1) A-, 230 V-		
Triac output	1 (1) A-, 230 V-		
Clock power supply	Battery CR2032 (Li-Mn) 3 V		
Clock accuracy	+/-1 s (24 h) at 20 °C		
Degree of protection	IP20 according to EN 60529		
Safety class	I according to EN 60730-1		
Operation mode	1B according to EN 60730-1		
Type of temperature sensors	Pt1000 or KTY10		
Operation mode	3-point PID		
Housing material	ASA - thermoplastic		
Permissible ambient temperature	5÷40 °C		
Storage temperature	-20÷65 °C		
Product weight	410 g	410 g	450 g
No. of pieces in the packaging unit	6 pcs		

Dimensions

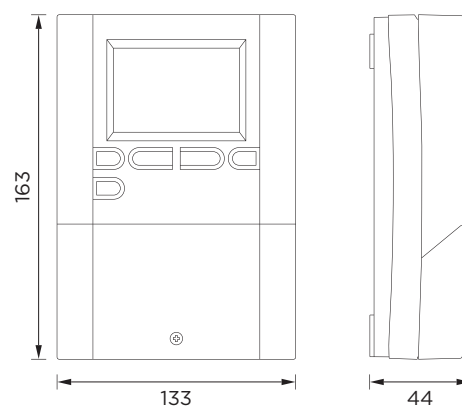

Electrical connection

**WDC10B**

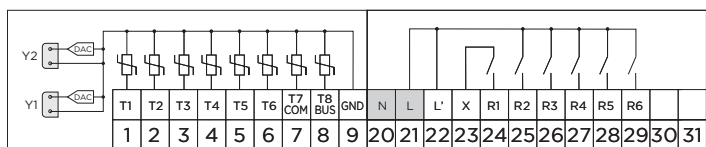

**WDC10**

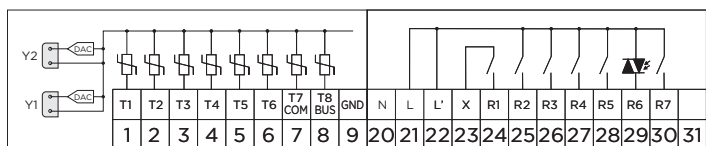



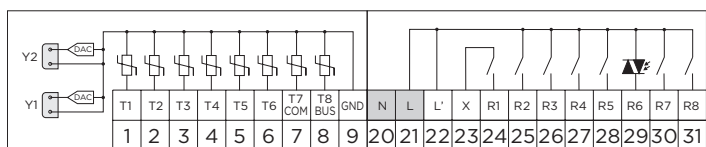







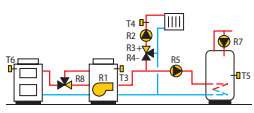

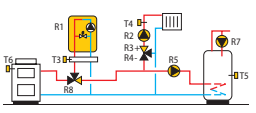

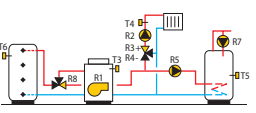

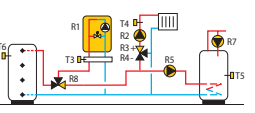
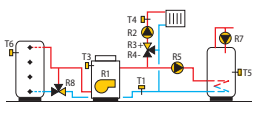
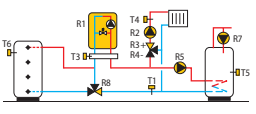
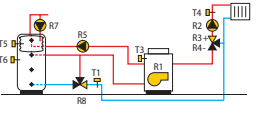

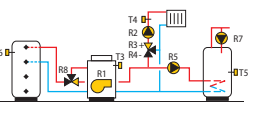
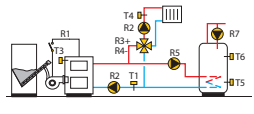

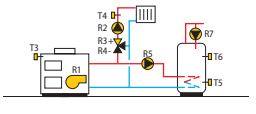
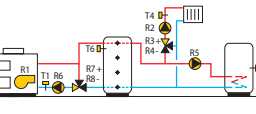
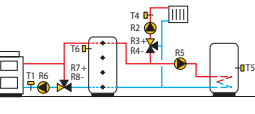
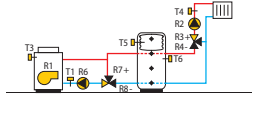
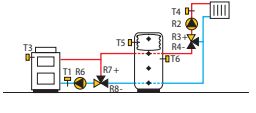
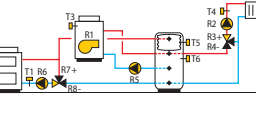

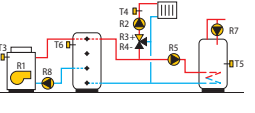

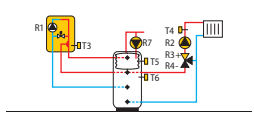

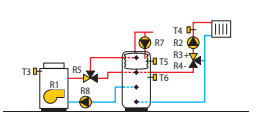

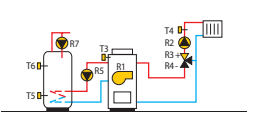
**WDC20**

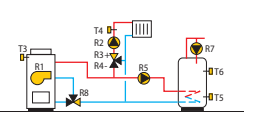

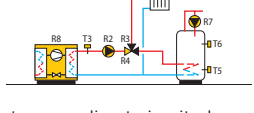
Hydraulic connections for WDC10B, WDC10, WDC20			
<p>401</p> <p>Oil boiler, mixing circuit, domestic hot water storage tank.</p>	<p>401b</p> <p>Storage tank, mixing circuit, domestic hot water storage tank.</p>	<p>401c</p> <p>Solid fuel boiler, mixing circuit, domestic hot water storage tank.</p>	<p>401d</p> <p>No-boiler system - mixing circuit, domestic hot water storage tank.</p>
<p>401e</p> <p>Extension scheme - mixing circuit, domestic hot water storage tank.</p>	<p>402</p> <p>Oil boiler, direct circuit, domestic hot water storage tank.</p>	<p>403</p> <p>Oil boiler, direct circuit, domestic hot water storage tank.</p>	

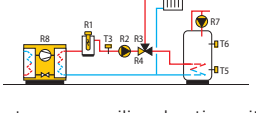

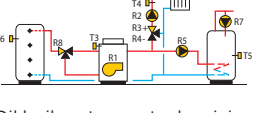
Hydraulic connections for WDC10, WDC20			
<p>404</p> <p>Oil boiler, mixing circuit, domestic hot water storage tank, solar collectors.</p>	<p>404b</p> <p>Storage tank, mixing circuit, domestic hot water storage tank, solar collectors.</p>	<p>404c</p> <p>Solid fuel boiler, mixing circuit, domestic hot water storage tank, solar collectors.</p>	<p>404d</p> <p>Storage tank with integrated domestic hot water storage tank, mixing circuit, solar collectors.</p>
<p>404e</p> <p>Storage tank with integrated domestic hot water storage tank, mixing circuit, auxiliary heating with electricity, solar collectors.</p>	<p>404f</p> <p>Extension scheme - mixing circuit, domestic hot water storage tank, solar collectors.</p>	<p>405</p> <p>Oil boiler, direct circuit, domestic hot water storage tank, solar collectors.</p>	<p>406</p> <p>Oil boiler, direct circuit, domestic hot water storage tank, solar collectors.</p>
<p>407</p> <p>Oil boiler, mixing circuit, direct circuit, domestic hot water storage tank.</p>	<p>407b</p> <p>Oil boiler, mixing circuit, direct circuit, domestic hot water storage tank, solar collectors.</p>		

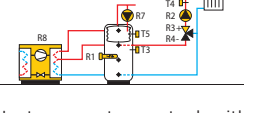
Hydraulic connections for WDC20







<p>T2  408</p>  <p>Solid fuel boiler, oil boiler, mixing circuit, domestic hot water storage tank.</p>	<p>T2  408b</p>  <p>Solid fuel boiler, gas boiler, mixing circuit, domestic hot water storage tank.</p>	<p>T2  409</p>  <p>Storage tank, oil boiler, mixing circuit, domestic hot water storage tank.</p>	<p>T2  409b</p>  <p>Storage tank, gas boiler, mixing circuit, domestic hot water storage tank.</p>
<p>T2 410</p>  <p>Storage tank, oil boiler, mixing circuit, domestic hot water storage tank.</p>	<p>T2 410b</p>  <p>Storage tank, gas boiler, mixing circuit, domestic hot water storage tank.</p>	<p>T2 410c</p>  <p>Storage tank with integrated domestic hot water storage tank, oil boiler, mixing circuit.</p>	<p>T2  411</p>  <p>Storage tank, oil boiler, mixing circuit, domestic hot water storage tank.</p>
<p>T2 412</p>  <p>Pellet boiler, mixing circuit, domestic hot water storage tank.</p>	<p>T2  413</p>  <p>Combined boiler (solid fuel/oil), mixing circuit, domestic hot water storage tank.</p>	<p>T2 414</p>  <p>Combined boiler (solid fuel/oil), storage tank, mixing circuit, domestic hot water storage tank.</p>	<p>T2 414b</p>  <p>Solid fuel boiler, storage tank, mixing circuit, domestic hot water storage tank.</p>
<p>T2 415</p>  <p>Combined boiler (solid fuel/oil), storage tank with integrated domestic hot water storage tank, mixing circuit.</p>	<p>T2 415b</p>  <p>Solid fuel boiler, storage tank with integrated domestic hot water storage tank, mixing circuit.</p>	<p>T2 415c</p>  <p>Solid fuel boiler, oil boiler, storage tank with integrated domestic hot water storage tank, mixing circuit.</p>	<p>T2  416</p>  <p>Oil boiler, storage tank, mixing circuit, domestic hot water storage tank.</p>
<p>T2  416b</p>  <p>Gas boiler, storage tank with integrated domestic hot water storage tank, mixing circuit.</p>	<p>T2  416c</p>  <p>Oil boiler, storage tank with integrated domestic hot water storage tank, mixing circuit.</p>	<p>T2  417</p>  <p>Combined boiler (solid fuel/oil), mixing circuit, domestic hot water storage tank.</p>	<p>T2  418</p>  <p>Combined boiler (solid fuel/oil), mixing circuit, domestic hot water storage tank.</p>
<p>T2  419</p>  <p>Heat pump, direct circuit, domestic hot water storage tank.</p>	<p>T2  420</p>  <p>Heat pump, auxiliary heating with electricity, direct circuit, domestic hot water storage tank.</p>	<p>T2  421</p>  <p>Oil boiler, storage tank, mixing circuit, domestic hot water storage tank.</p>	<p>T2  422</p>  <p>Heat pump, storage tank with integrated domestic hot water storage tank, auxiliary heating with electricity, mixing circuit.</p>



Hydraulic connections for WDC20			
<p>422b</p> <p>Heat pump, oil boiler, storage tank with integrated domestic hot water storage tank, mixing circuit.</p>	<p>422c</p> <p>Heat pump, oil boiler, storage tank, mixing circuit, domestic hot water storage tank.</p>	<p>422d</p> <p>Heat pump, oil boiler, storage tank with integrated domestic hot water storage tank, mixing circuit.</p>	<p>423</p> <p>Oil boiler, 2 mixing circuits, domestic hot water storage tank.</p>
<p>423b</p> <p>Storage tank with integrated domestic hot water storage tank, oil boiler, 2 mixing circuits.</p>	<p>423c</p> <p>Gas boiler, storage tank with integrated domestic hot water storage tank, 2 mixing circuits.</p>	<p>423d</p> <p>Storage tank with integrated domestic hot water storage tank, heating with electricity, 2 mixing circuits.</p>	<p>423e</p> <p>Storage tank, 2 mixing circuits, domestic hot water storage tank.</p>
<p>423f</p> <p>Solid fuel boiler, 2 mixing circuits, domestic hot water storage tank.</p>	<p>423g</p> <p>Combined boiler (solid fuel/oil), 2 mixing circuits, domestic hot water storage tank.</p>	<p>423h</p> <p>Extension scheme, domestic hot water storage tank, 2 mixing circuits.</p>	

Item	Order code	Description
	2WDC10B00000-010	Weather compensated controller SELTRON WDC10B
	2WDC1000000-010	Weather compensated controller SELTRON WDC10
	2WDC2000000-010	Weather compensated controller SELTRON WDC20
	2WDC10B21100-010	Weather compensated controller SELTRON WDC10B with sensors (2×TF/Pt, 1×VF/Pt, 1×AF/Pt)
	2WDC1041100-010	Weather compensated controller SELTRON WDC10 with sensors (4×TF/Pt, 1×VF/Pt, 1×AF/Pt)
	2WDC2041100-010	Weather compensated controller SELTRON WDC20 with sensors (4×TF/Pt, 1×VF/Pt, 1×AF/Pt)

#### Accessories

	1TFPT-000	Immersion temperature sensor SELTRON TF/Pt
	1VFPT-000	Surface temperature sensor SELTRON VF/Pt
	1FODPT-NNO	Outdoor temperature sensor SELTRON AFD/Pt
	1AVD0532M210-030	Actuator SELTRON AVD 05, 3-point, 5 Nm, 2 min, 230 V-
	1AVD0521M210-030	Actuator SELTRON AVD 05R, 2-point, 5 Nm, 1 min, 230 V-
	1RBD30F-060	Room unit SELTRON RCD20, wired connection, wall mounting
	1GWD3E-050	Communication module SELTRON GWD3E



Seltron d.o.o.  
Tržaška cesta 85 A  
SI-2000 Maribor  
Slovenia

T: +386 (0)2 671 96 00  
F: +386 (0)2 671 96 66  
sales@seltron.eu  
www.seltron.eu