

# Installation

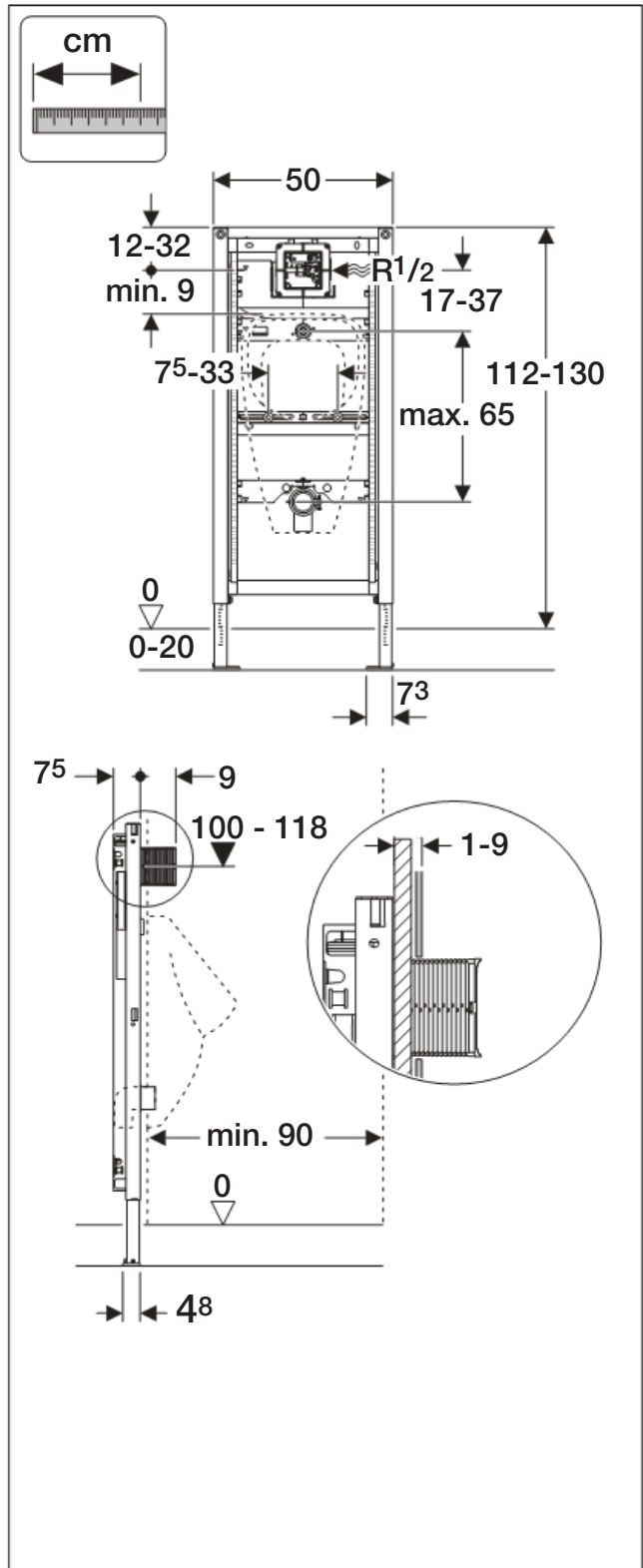

D32905-001&BDC © 09-2008

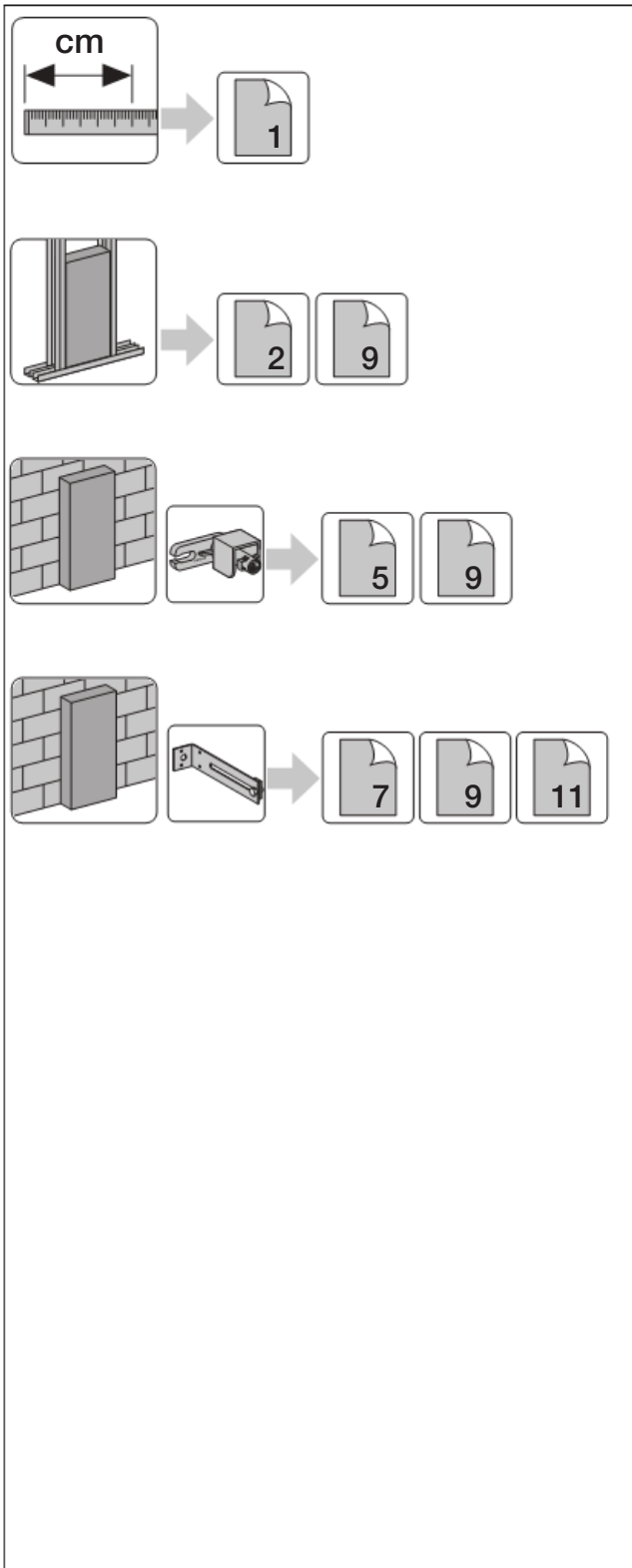
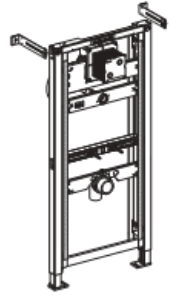