

Data Sheet

Lockshield Valve Type RLV - with Selfsealing Tailpiece & Connection to Drain Tap

Application



RLV straight



RLV angle

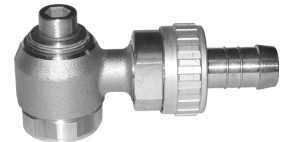

Drain tap

By means of a RLV lockshield valve every radiator can be shut off individually to allow trouble-free maintenance or repair without affecting other radiators in the system.

RLV lockshield valves are available with self sealing tailpiece in DN 15, angle and straight versions.

RLV lockshield valves can be preset to limit the max. water flow. Factory setting is fully open valve.

Dimensions according to DIN 3842-1.

In order to avoid deposition and corrosion the composition of the hot system water must be in accordance to the VDI 2035 guide line (Verein Deutscher Ingenieure).

System

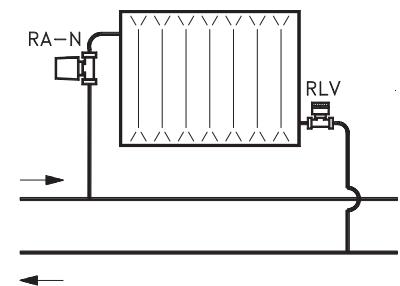
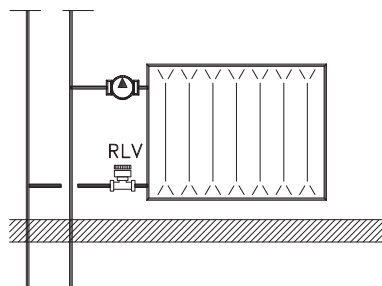



Data and Ordering

Type	Connections ISO 7-1		Flow limitation: k_v -values (m^3/h) for number of turns										Code no.	
	Sys-tem	Radia-tor	0.25	0.5	0.75	1.0	1.5	2	2.5	3.0	3.5	4.0		k_{vs}
DN 15 angle	1/2	1/2	0.2	0.4	0.5	0.65	1.0	1.3	0.17	1.9	2.1	2.3	2.5	003L0343
DN 15 straight			0.2	0.4	0.5	0.65	1.0	1.3	0.17	1.9	2.1	2.3	2.5	003L0344

Max. working pressure: 10 bar, test pressure: 16 bar, max. water temperature: 120 °C.

RLV can be connected to PEX, AluPEX, steel or copper system tubing using Danfoss compression fittings.

Accessories

Product		Code no.
Drain tap with 3/4" hose nozzle		003L0152
Brass handwheel - temporarily replacement for the thermostat when the radiator is drained		013G3300

Mounting

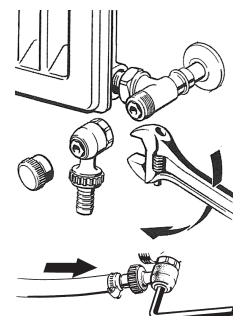
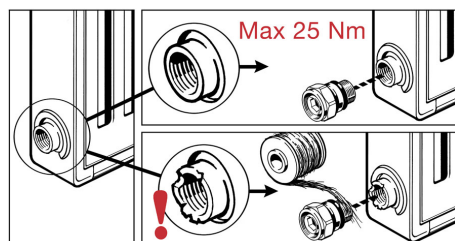

RLV
 The RLV lockshield valve is intended for mounting on the outlet of the radiator. To enable subsequent draining of the radiator water, the lockshield valve should be mounted with its cover towards the front. Mounting is very easy due to the new self sealing tailpiece. If the radiator connections are of poor quality conventional packing materials can be used.

Drain tap
 For mounting and operation of the drain tap, the following procedure is recommended:

1. Shut off the radiator inlet valve. As a safety precaution the thermostatic sensor should be replaced by a Danfoss manual shut off handle, code no. 013G3300.
2. Remove the cover and shut off the valve by means of a 6 mm Allen key.
3. Mount the drain tap and align the drain branch, which can revolve in any direction.
4. Open the valve for draining.

Capacity

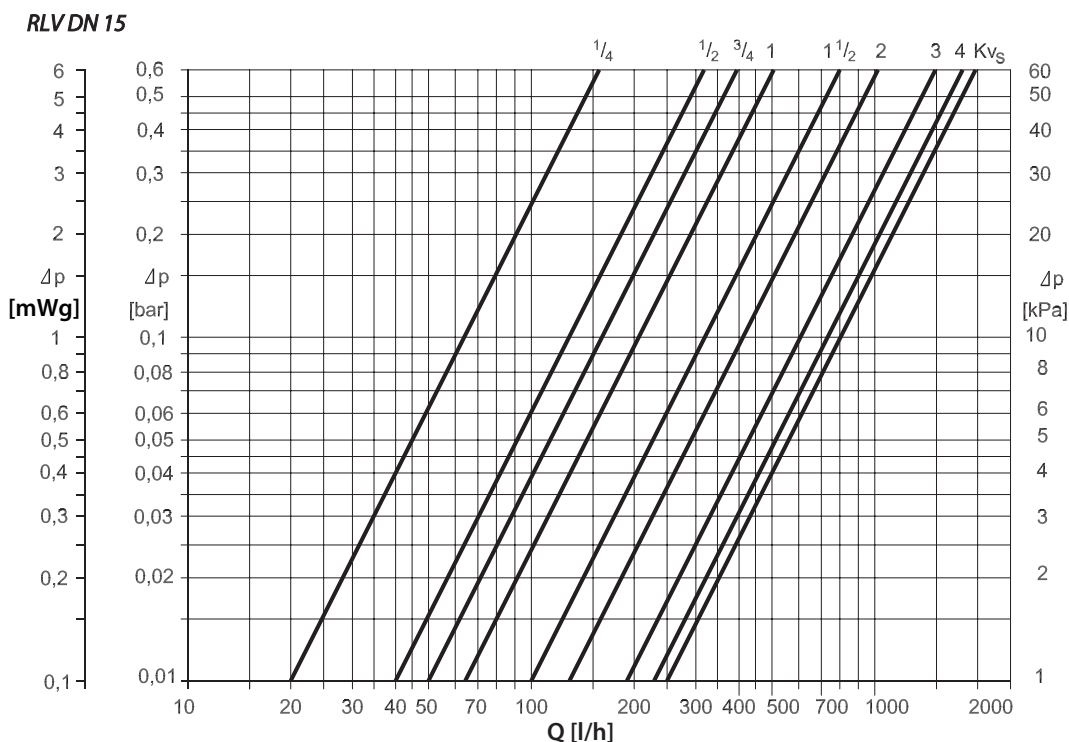

Setting

How to set maximum water flow:

- Close the valve by means of a 6 mm Allen key.
- Regulate the water flow by opening the valve. The capacity diagrammes on page 3 show the water flow at 1/4 - 4 turns and for fully open valve (k_{vs}).

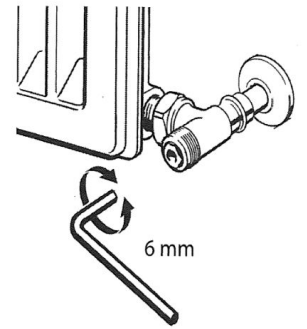

Construction

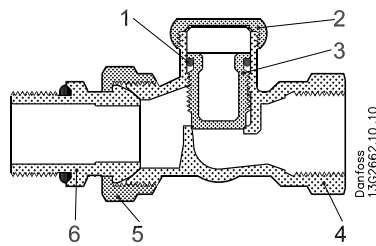

- | | |
|------------------|---------------|
| 1. Cap | 4. Valve body |
| 2. Guide sleeve | 5. Union nut |
| 3. Shut-off cone | 6. Tail piece |

Materials in contact with water

Valve body and other metal parts	Ms 58
O-ring	EPDM

Dimensions

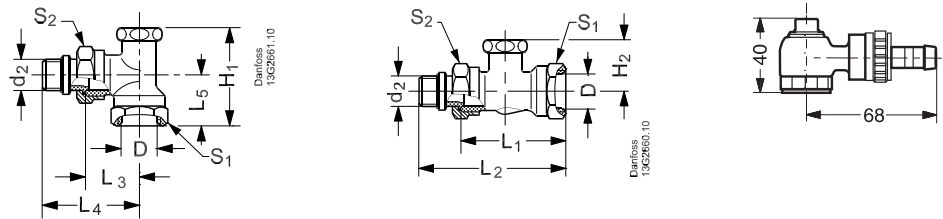

Type	D	d ₂	H ₁	H ₂	L ₁	L ₂	L ₃	L ₄	L ₅	S ₁	S ₂
RLV 15	R _p 3/4	R 3/4	63	41	53	80	30	57	27	27	30

Danfoss A/S
Heating Solutions
Haarupvaenget 11
8600 Silkeborg
Denmark
Phone: +45 7488 8000
Fax: +45 7488 8100
Email: heating.solutions@danfoss.com
www.heating.danfoss.com

Danfoss can accept no responsibility for possible errors in catalogues, brochures and other printed material. Danfoss reserves the right to alter its products without notice. This also applies to products already on order provided that such alterations can be made without subsequential changes being necessary in specifications already agreed. All trademarks in this material are property of the respective companies. Danfoss and the Danfoss logotype are trademarks of Danfoss A/S. All rights reserved.
