

TECHNICAL CATALOGUE

HITACHI

Cooling & Heating

RAK-DJ18RHAE
RAK-DJ25RHAE
RAK-DJ35RHAE
RAK-DJ50RHAE



RAC-DJ18WHAE
RAC-DJ25WHAE
RAC-DJ35WHAE

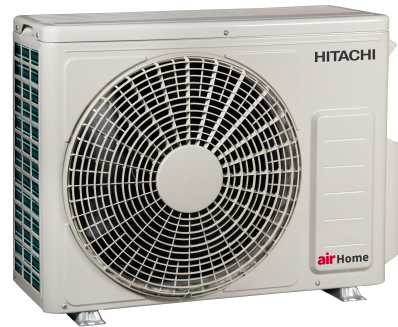

RAC-DJ50WHAE

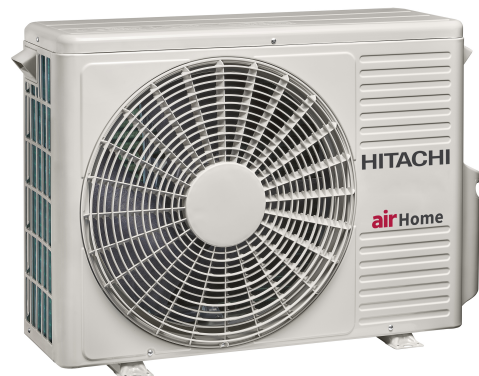

HITACHI

**Specifications in this catalogue are subject to change without prior notice in order for
HITACHI to bring in the latest innovations to their customers**

**Whilst every effort is made to ensure that all dimensions and specifications are correct, any
printers' error not rectified are outside the control of HITACHI, who cannot be held responsible
for the same**

CONTENTS

CONTENTS	1
1 SPECIFICATIONS	2
2 DIMENSIONAL DATA	4
3 CAPACITIES TABLE	7
3.1. CAPACITY CHARACTERISTIC CURVES	7
3.2. CORRECTION FACTORS ACCORDING TO PIPING LENGTH	10
3.3. CORRECTION FACTORS ACCORDING TO DEFROSTING OPERATION	12
4 SOUND DATA	13
5 WORKING RANGE	17
5.1. POWER SUPPLY	17
5.2. WORKING RANGE	17
6 ELECTRICAL DATA	18
6.1. INDOOR UNIT	18
6.2. OUTDOOR UNIT	18
7 WIRING DIAGRAM	19
8 REFRIGERANT CYCLE	21
9 CONTROL AND FUNCTION	22
9.1. RC-AGU1EA0G	22
9.2. HOW TO SET UP FROM SERVICE SETTING MODE	23
9.3. HOW TO OPERATE THE HHRC METHOD	24
9.4. HOW TO ADJUST FILTER SIGN TIME	24
9.5. SERVICE SETTING ITEM USED FOR GRAC WH EU ENTRY	25
9.6. BUZZER SOUNDING FOR SHOWING ERROR CONTENTS	27
9.7. OTHER SETTING	28
9.8. ERROR CODE INFORMATION	28
9.9.1. HOW TO DISPLAY ERROR CODE	28
9.9.2. HOW TO REMOVE ERROR CODE	30
10 OPTION LIST	31
10.1 H-LINK ADAPTOR	31
10.1.1 SAFETY SUMMARY	31
10.1.2 INSTALLATION WORK	31
10.1.3 ELECTRICAL WIRING	32
10.1.4 DIP SWITCH SETTING	33
10.1.5 TEST RUN	34
10.2 DRY CONTACT APPLICATION	35
10.3 WIRED REMOTE CONTROL - SPX-URFG	37
10.3.1 SERVICE & INSTALLATION SCREEN	38
10.3.2 SERVICE SETTINGS	42

1 SPECIFICATIONS

1.1. WALL TYPE

INDOOR	Unit	RAK-DJ18RHAE	RAK-DJ25RHAE	RAK-DJ35RHAE	RAK-DJ50RHAE
Nominal capacity adjustable		no	no	no	no
Nominal Cooling capacity (min - max)	kW	2.00 (0.90 - 2.50)	2.50 (0.90 - 3.10)	3.50 (0.90- 4.00)	5.00 (1.90- 5.20)
Cooling sensible capacity	kW	1.90	2.25	2.70	3.45
Nominal Heating capacity (min - max)	kW	2.50 (0.90 - 3.20)	3.40 (0.90- 4.40)	4.20 (0.90- 5.00)	6.00 (2.20- 7.30)
Noise level cooling (sound pressure) (SL / L / M / H / SH)	dB(A)	20/24/29/33/37	20/24/30/36/40	20/27/35/39/43	28/33/38/42/46
Noise level heating (sound pressure) (SL / L / M / H / SH)	dB(A)	20/24/30/34/38	20/25/31/36/41	20/28/36/40/44	25/31/37/42/47
Noise level (sound power)	dB(A)	51	54	57	60
Air flow cooling mode (SL / L / M / H / SH)	m ³ /h	204/255/384/431/545	204/255/394/513/620	204/302/446/608/653	265/360/528/608/663
Air flow heating mode (SL / L / M / H / SH)	m ³ /h	218/287/446/505/611	218/310/460/569/683	218/407/569/653/773	255/413/528/687/749
Fan Motor	W	18	18	18	38
Dehumidification	l/h	1.2	1.4	1.6	2
Dimensions (H x W x D)	mm	280 x 780 x 222	280 x 780 x 222	280 x 780 x 222	280 x 780 x 222
Weight	kg	7.7	7.7	7.7	8.4
Colour		star white *ZYY8001	star white *ZYY8001	star white *ZYY8001	star white *ZYY8001
Condensate Drain	mm	φ16mm	φ16mm	φ16mm	φ16mm
Running current (C/H)	A	1.09-4.39/1.09-4.22	1.09-5.61/1.09-5.43	1.09-6.35/1.09-7.39	2.17-9.13/2.17-11.96
Power supply		220-240V	220-240V	220-240V	220-240V
Cable section (interconnection)	mm ²	1.50x 3+EARTH/-	1.50x 3+EARTH/-	1.50x 3+EARTH/-	2.50x 3+EARTH/-
Piping diameter (Liq / Gas)	Inch	1/4" / 3/8"	1/4" / 3/8"	1/4" / 3/8"	1/4" / 3/8"
Drain diameter (ext)	mm	φ16mm	φ16mm	φ16mm	φ16mm
Remote control (standard/optional)		RC-AGU1EA0G/SPX-URFG	RC-AGU1EA0G/SPX-URFG	RC-AGU1EA0G/SPX-URFG	RC-AGU1EA0G/SPX-URFG
Filter					
ACL Filter Optional		-	-	-	-
ACL part name		-	-	-	-
Pre-filter(Standard/Optional)		WASHABLE/-	WASHABLE/-	WASHABLE/-	WASHABLE/-

NOTE:

1. The nominal cooling and heating capacity is the combined capacity of the HITACHI standard split system, and are based on the EN 14511.

Operation Conditions		Cooling	Heating
Indoor Air Inlet Temperature	dB	27.0 °C	20.0 °C
	WB	19.0 °C	15.0 °C
Outdoor Air Inlet Temperature	dB	35.0 °C	7.0 °C
	WB	24.0 °C	6.0 °C
Piping Length: 5.0 meters; Piping Lift: 0 meter			
dB: Dry Bulb; WB: Wet Bulb			

2. The Sound Pressure Level is based on the following conditions:

- 0.8 meter beneath indoor height center
- 1 meter from Discharge grille

The above data was measured in an anechoic chamber. Please take into consideration reflected sound of your specific site

1.2. WALL TYPE

OUTDOOR	UNIT	RAC- DJ18WHAE	RAC- DJ25WHAE	RAC- DJ35WHAE	RAC- DJ50WHAE	
Nominal Cooling capacity (min - max)	kW	2.00 (0.90 - 2.50)	2.50 (0.90 - 3.10)	3.50 (0.90- 4.00)	5.00 (1.90- 5.20)	
Nominal Heating capacity (min - max)	kW	2.50 (0.90 - 3.20)	3.40 (0.90- 4.40)	4.20 (0.90- 5.00)	6.00 (2.20- 7.30)	
Nominal cooling power input (min - max)	kW	0.58(0.25-1.01)	0.70 (0.25 - 1.29)	1.084 (0.25 - 1.46)	1.548(0.50 - 2.10)	
Nominal heating power input (min - max)	kW	0.595(0.25-0.97)	0.85 (0.25 - 1.25)	1.050(0.25 - 1.70)	1.617(0.50 - 2.75)	
EER / COP		3.45/4.20	3.57/4.00	3.23/4.00	3.23/3.71	
SEER / SCOP		7.50/4.60	7.50/4.60	7.50/4.60	7.00/4.50	
Energy class (SEER/SCOP)		A++/A++	A++/A++	A++/A++	A++/A+	
Noise level cooling (sound pressure)	dB(A)	45	47	48	50	
Noise level heating (sound pressure)	dB(A)	46	48	49	51	
Noise level (sound power)	dB(A)	59	61	62	64	
Air flow (Cooling / Heating)	m ³ /h	1860 / 1620	1860 / 1620	1860 / 1620	2160 / 2160	
Dimensions (H x W x D)	mm	530x660 x278	530x660 x278	530x660 x278	600x792x299	
Weight	kg	23	23	24.4	39.1	
Colour (Munsell Code)		Beige (5Y7/2)	Beige (5Y7/2)	Beige (5Y7/2)	Beige (5Y7/2)	
Power supply	V/Ph/Hz	220-240V / 1Ph / 50Hz	220-240V / 1Ph / 50Hz	220-240V / 1Ph / 50Hz	220-240V / 1Ph / 50Hz	
Recommended fuse size	A	15	15	15	25	
Starting current(C/H)	A	3.22/3.51	3.89/4.53	5.38/5.30	7.11/7.42	
Running current (C/H)	A	1.09-4.39/1.09-4.22	1.09-5.61/1.09-5.43	1.09-6.35/1.09-7.39	2.17-9.13/2.17-9.57	
Cable section (power)	mm ²	1.50x 2+EARTH	1.50x 2+EARTH	1.50x 2+EARTH	2.50x 2+EARTH	
Cable section (Interconnection)	mm ²	1.50x 3+EARTH	1.50x 3+EARTH	1.50x 3+EARTH	2.50x 3+EARTH	
Piping diameter (Liq / Gas)	Inch	1/4" / 3/8"	1/4" / 3/8"	1/4" / 3/8"	1/4" / 3/8"	
Minimum piping length	m	3	3	3	3	
Maximum piping length / height difference	m	20 / 10	20 / 10	20 / 10	20 / 10	
Current quantity of refrigerant / Chargeless	kg	0.58	0.580	0.720	0.930	
Chargeless length / Additional refrigerant charge	m / g/m	20/-	20/-	20/-	20/-	
Working range (cooling / heating)	°C	-10°C—46°C/-15°C—21°C	-10°C—46°C/-15°C—21°C	-10°C—46°C/-15°C—21°C	-10°C—46°C/-15°C—21°C	
Refrigerant		R32	R32	R32	R32	
Condenser Fan		Propeller Fan	Propeller Fan	Propeller Fan	Propeller Fan	
Compressor	Type		ROTARY	ROTARY	ROTARY	2 Cylinder Rotary
	Oil Charge	mL	ACS-68R or equivalent	ACS-68R or equivalent	ACS-68R or equivalent	ACS-68R or equivalent
	Oil Type		320±20	320±20	320±20	480±20
	Coil resistance	Ω	2.084 at 20°C	2.084 at 20°C	2.084 at 20°C	1.354 at 20°C
	Quantity		1	1	1	1

NOTE:

1. The Sound Pressure Level is based on the following conditions:

- 1 meter from the unit front surface and 1 meter from floor level

The above data was measured in an anechoic chamber. Please take into consideration reflected sound of your specific site

2 DIMENSIONAL DATA

2.1. WALL TYPE: RAK-DJ18RHAE, RAK-DJ25RHAE, RAK-DJ35RHAE, RAK-DJ50RHAE

Unit: mm

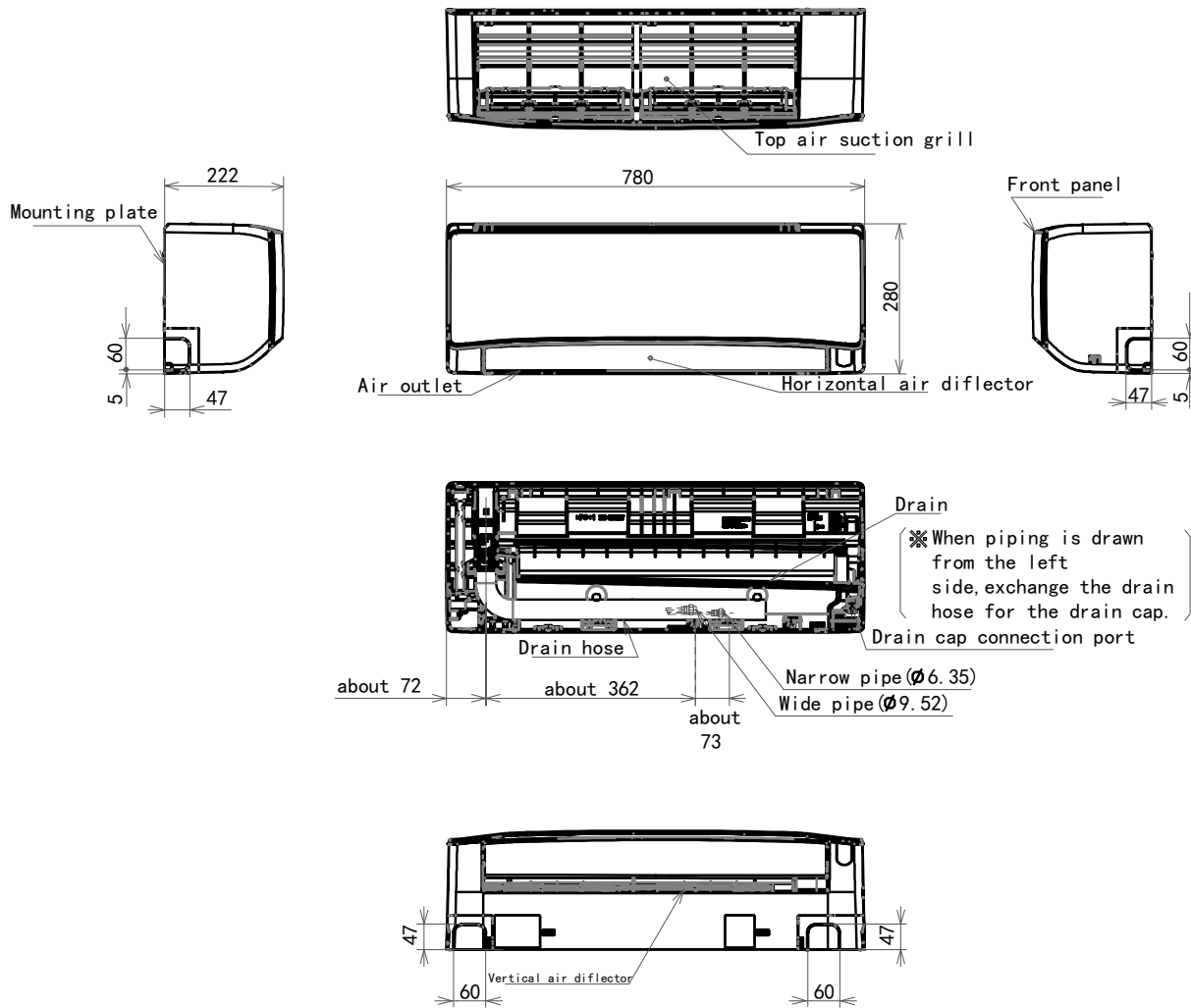

2.2. WALL TYPE: RAC-DJ18WHAE,RAC-DJ25WHAE,RAC-DJ35WHAE

Unit: mm

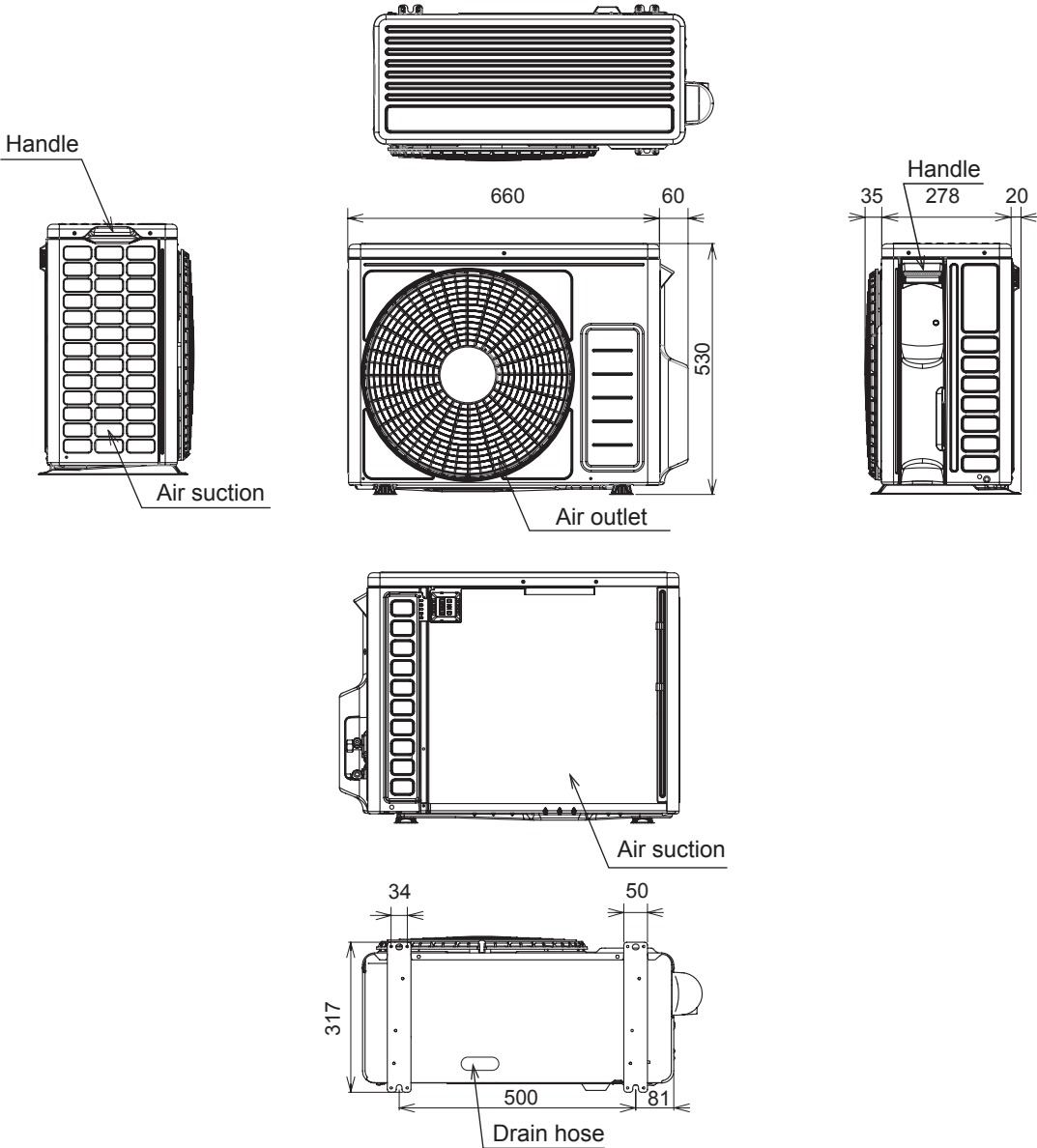

2.3. WALL TYPE: RAC-DJ50WHAЕ

Unit : mm

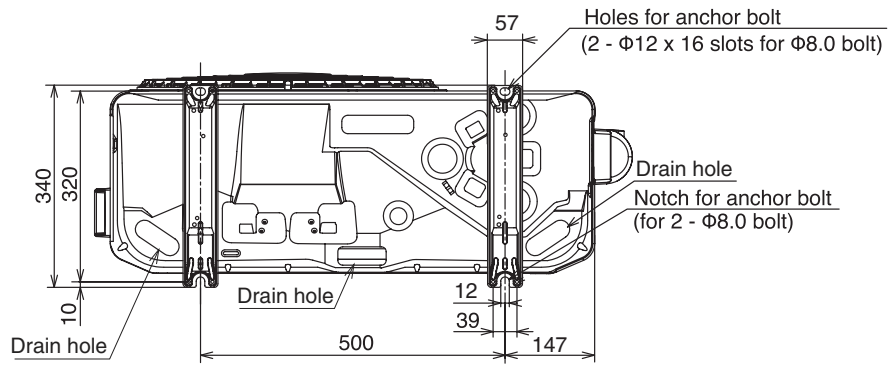
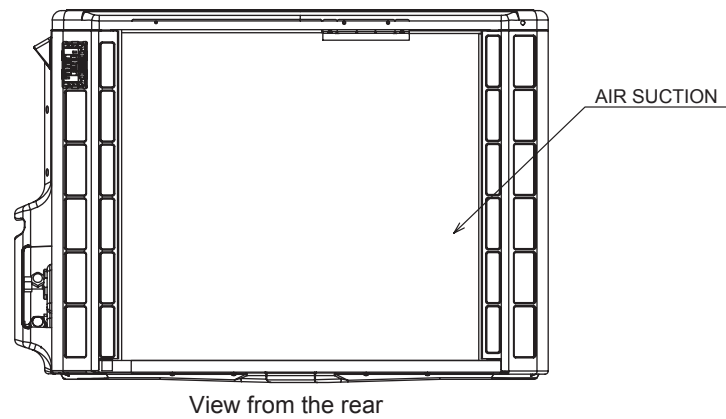
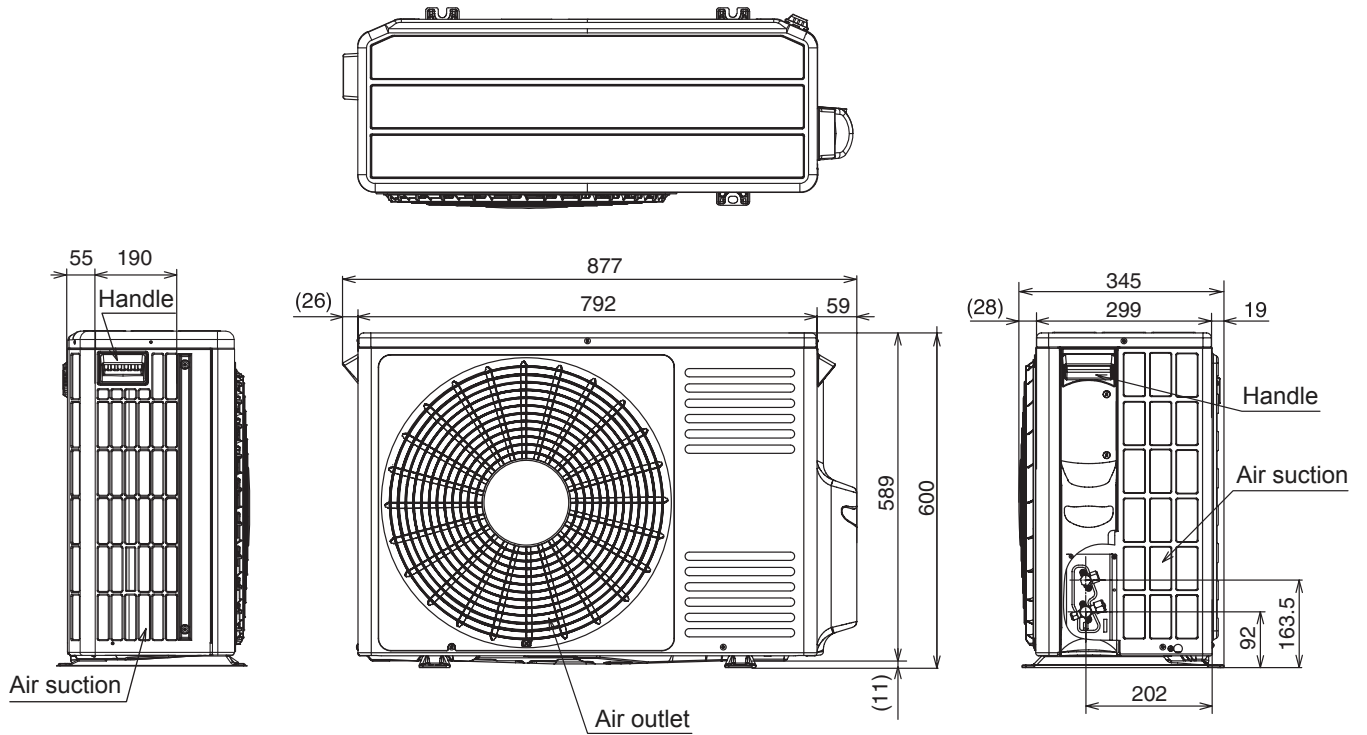

3 CAPACITIES TABLE

3.1. CAPACITY CHARACTERISTIC CURVES

The following charts show the characteristics of outdoor unit capacity, which corresponds with the operating ambient temperature of outdoor unit.

Conditions:

① Pipe length / height difference : 5m / 0m

③ Compressor at rated inverter frequency

② Indoor fan speed at High mode

④ Capacity loss due to white frost and defrost operation is not included.

3.1.1. RAK-DJ18RHAE/RAC-DJ18WHAE

COOLING [50Hz, 230V]

INDOOR		OUTDOOR TEMPERATURE (°CDW)																				
EWB	EDB	-10			21			27			32			35			40			43		
°C	°C	TC	SHC	PI	TC	SHC	PI	TC	SHC	PI	TC	SHC	PI	TC	SHC	PI	TC	SHC	PI	TC	SHC	PI
12.0	18	1660	1552	345	1880	2070	410	1740	1910	483	1640	1811	534	1580	1731	557	1480	1631.8	597	1420	1552.2	621
14.0	20	1660	1552	345	2020	2070	410	1880	1930	489	1760	1811	539	1700	1751	563	1580	1631.8	603	1520	1572	632
16.0	22	1660	1652	351	2160	2070	415	2000	1930	495	1880	1811	545	1820	1751	574	1700	1631.8	615	1640	1572	638
18.0	25	1780	1771	356	2300	2249	421	2120	2090	500	2000	1970	551	1920	1891	574	1800	1771	621	1720	1692	644
19.0	27	1840	1831	361	2380	2368	426	2200	2189	506	2080	2070	557	2000	1990	580	1880	1870.6	621	1800	1791	644
22.0	30	2040	1811	361	2640	2348	426	2440	2169	506	2300	2050	563	2220	1970	586	2000	1910.4	644	1860	1870.6	679
24.0	32	2180	1811	367	2820	2348	432	2600	2169	512	2460	2050	563	2360	1970	592	2080	1950.2	661	1900	1930	702

HEATING [50Hz, 230V]

INDOOR		OUTDOOR TEMPERATURE (°CDW)																						
EDB	-15	-10			-7			-5			0			7			10			15				
°C	TC	SHC	PI	TC	SHC	PI	TC	SHC	PI	TC	SHC	PI	TC	SHC	PI	TC	SHC	PI	TC	SHC	PI	TC	SHC	PI
16	1625		638	2063		732	2332		781	2365		747	2440		672	2529		548	2790		602	3246		690
18	1613		644	2050		738	2316		791	2347		759	2420		685	2514		572	2776		627	3223		717
20	1600		650	2038		744	2300		800	2329		771	2400		698	2500		595	2763		651	3200		745
22	1588		656	2025		750	2284		809	2310		782	2380		710	2486		618	2749		676	3177		773
24	1575		662	2013		756	2268		819	2292		794	2360		723	2471		642	2735		701	3154		800

EWB : Evaporator Wet Bulb temperature (°C)

EDB : Evaporator Dry Bulb temperature (°C)

(°CDB) : Outdoor Unit Inlet Air Dry Bulb Temperature (°C)

TC : Total Capacity (W)

SHC : Sensible Heating Capacity (W)

PI : Power Input

3.1.2. RAK-DJ25RHAE/RAC-DJ25WHAE

COOLING [50Hz, 230V]

INDOOR		OUTDOOR TEMPERATURE (°CDW)																				
EWB	EDB	-10			21			27			32			35			40			43		
°C	°C	TC	SHC	PI	TC	SHC	PI	TC	SHC	PI	TC	SHC	PI	TC	SHC	PI	TC	SHC	PI	TC	SHC	PI
12.0	18	2075	1778	417	2350	2371	495	2175	2189	583	2050	2075	644	1975	1984	672	1850	1869.6	721	1775	1778.4	749
14.0	20	2075	1778	417	2525	2371	495	2350	2212	590	2200	2075	651	2125	2006	679	1975	1869.6	728	1900	1801	763
16.0	22	2075	1892	423	2700	2371	501	2500	2212	597	2350	2075	658	2275	2006	693	2125	1869.6	742	2050	1801	770
18.0	25	2225	2029	430	2875	2576	508	2650	2394	604	2500	2257	665	2400	2166	693	2250	2029	749	2150	1938	777
19.0	27	2300	2098	436	2975	2713	514	2750	2508	611	2600	2371	672	2500	2280	700	2350	2143.2	749	2250	2052	777
22.0	30	2550	2075	436	3300	2690	514	3050	2485	611	2875	2348	679	2775	2257	707	2500	2188.8	777	2325	2143.2	819
24.0	32	2725	2075	443	3525	2690	521	3250	2485	617	3075	2348	679	2950	2257	714	2600	2234.4	798	2375	2212	847

HEATING [50Hz, 230V]

INDOOR		OUTDOOR TEMPERATURE (°CDW)																						
EDB	-15	-10			-7			-5			0			7			10			15				
°C	TC	SHC	PI	TC	SHC	PI	TC	SHC	PI	TC	SHC	PI	TC	SHC	PI	TC	SHC	PI	TC	SHC	PI	TC	SHC	PI
16	2334		933	2834		1027	3143		1073	3192		1031	3304		939	3439		783	3737		836	4263		921
18	2317		942	2817		1035	3121		1087	3168		1047	3277		957	3420		817	3719		871	4231		960
20	2300		950	2800		1044	3100		1100	3143		1064	3250		975	3400		850	3700		906	4200		1000
22	2283		959	2783		1052	3079		1113	3118		1081	3223		993	3380		883	3681		942	4169		1040
24	2266		967	2766		1061	3057		1127	3094		1098	3196		1011	3361		917	3663		977	4137		1079

3.1.3. RAK-DJ35RHAE/RAC-DJ35WHAE

COOLING [50Hz, 230V]

INDOOR		OUTDOOR TEMPERATURE (°CDW)																				
EWB	EDB	-10			21			27			32			35			40			43		
°C	°C	TC	SHC	PI	TC	SHC	PI	TC	SHC	PI	TC	SHC	PI	TC	SHC	PI	TC	SHC	PI	TC	SHC	PI
12.0	18	2453	1890	545	3290	2985	766	3045	2755	903	2870	2612	997	2765	2497	1041	2590	2353.4	1117	2485	2238.6	1160
14.0	20	2453	1890	545	3535	2985	766	3290	2784	914	3080	2612	1008	2975	2526	1051	2765	2353.4	1127	2660	2267	1182
16.0	22	2453	2012	553	3780	2985	776	3500	2784	924	3290	2612	1019	3185	2526	1073	2975	2353.4	1149	2870	2267	1192
18.0	25	2630	2157	562	4025	3243	786	3710	3014	935	3500	2841	1030	3360	2727	1073	3150	2554	1160	3010	2440	1203
19.0	27	2719	2230	570	4165	3415	796	3850	3157	945	3640	2985	1041	3500	2870	1084	3290	2697.8	1160	3150	2583	1203
22.0	30	3015	2205	570	4620	3387	796	4270	3128	945	4025	2956	1051	3885	2841	1095	3500	2755.2	1203	3255	2697.8	1268
24.0	32	3222	2205	579	4935	3387	806	4550	3128	956	4305	2956	1051	4130	2841	1106	3640	2812.6	1236	3325	2784	1312

HEATING [50Hz, 230V]

INDOOR		OUTDOOR TEMPERATURE (°CDW)																						
EDB	-15	-10			-7			-5			0			7			10			15				
°C	TC	SHC	PI	TC	SHC	PI	TC	SHC	PI	TC	SHC	PI	TC	SHC	PI	TC	SHC	PI	TC	SHC	PI	TC	SHC	PI
16	2742		1029	3492		1185	3953		1267	4004		1223	4117		1130	4248		968	4696		1057	5478		1202
18	2721		1040	3471		1196	3927		1283	3973		1244	4084		1153	4224		1009	4673		1100	5439		1251
20	2700		1050	3450		1206	3900		1300	3943		1264	4050		1175	4200		1050	4650		1144	5400		1300
22	2679		1061	3429		1217	3873		1317	3912		1285	4016		1197	4176		1091	4627		1187	5361		1349
24	2658		1071	3408		1227	3847		1333	3882		1306	3983		1220	4152		1132	4604		1231	5322		1398

EWB : Evaporator Wet Bulb temperature (°C)
EDB : Evaporator Dry Bulb temperature (°C)
(°CDB) : Outdoor Unit Inlet Air Dry Bulb Temperature (°C)

TC : Total Capacity (W)
SHC : Sensible Heating Capacity (W)
PI : Power Input

3.1.4. RAK-DJ50RHAE/RAC-DJ50WHAE

COOLING [50Hz, 230V]

INDOOR		OUTDOOR TEMPERATURE (°CDW)																				
EWB	EDB	-10			21			27			32			35			40			43		
°C	°C	TC	SHC	PI	TC	SHC	PI	TC	SHC	PI	TC	SHC	PI	TC	SHC	PI	TC	SHC	PI	TC	SHC	PI
12.0	18	3228	2105	717	4700	3609	1094	4350	3331	1289	4100	3158	1424	3950	3019	1486	3700	2845.4	1594	3550	2706.6	1656
14.0	20	3228	2105	717	5050	3609	1094	4700	3366	1305	4400	3158	1440	4250	3054	1502	3950	2845.4	1610	3800	2741	1687
16.0	22	3228	2240	728	5400	3609	1109	5000	3366	1320	4700	3158	1455	4550	3054	1533	4250	2845.4	1641	4100	2741	1703
18.0	25	3461	2402	739	5750	3921	1123	5300	3644	1335	5000	3435	1471	4800	3297	1533	4500	3088	1656	4300	2950	1718
19.0	27	3578	2483	750	5950	4129	1137	5500	3817	1350	5200	3609	1486	5000	3470	1548	4700	3261.8	1656	4500	3123	1718
22.0	30	3967	2456	750	6600	4095	1137	6100	3782	1350	5750	3574	1502	5550	3435	1563	5000	3331.2	1718	4650	3261.8	1811
24.0	32	4239	2456	761	7050	4095	1152	6500	3782	1365	6150	3574	1502	5900	3435	1579	5200	3400.6	1765	4750	3366	1873

HEATING [50Hz, 230V]

INDOOR		OUTDOOR TEMPERATURE (°CDW)																				
EDB	-15	-10			-7			-5			0			7			10			15		
°C	TC	SHC	PI	TC	SHC	PI	TC	SHC	PI	TC	SHC	PI	TC	SHC	PI	TC	SHC	PI	TC	SHC	PI	
16	3960	1668	4773	1793	5276	1849	5401	1796	5696	1690	6069	1490	6554	1558	7411	1667						
18	3930	1684	4743	1809	5238	1874	5358	1828	5648	1724	6035	1554	6521	1625	7356	1742						
20	3900	1700	4713	1825	5200	1900	5314	1860	5600	1759	6000	1617	6488	1692	7300	1817						
22	3870	1716	4683	1841	5162	1926	5271	1892	5552	1793	5966	1680	6455	1759	7245	1892						
24	3840	1732	4653	1857	5124	1951	5227	1923	5504	1827	5931	1744	6422	1826	7189	1967						

EWB : Evaporator Wet Bulb temperature (°C)
 EDB : Evaporator Dry Bulb temperature (°C)
 (°CDB) : Outdoor Unit Inlet Air Dry Bulb Temperature (°C)

TC : Total Capacity (W)
 SHC : Sensible Heating Capacity (W)
 PI : Power Input

3.2. CORRECTION FACTORS ACCORDING TO PIPING LENGTH

Correction Factor for **Cooling Capacity** according to Piping Length

The cooling capacity should be corrected according to the following formula:

$$CCA = CC \times F$$

- CCA: Actual Corrected Cooling Capacity (kcal/h)
- CC: Cooling Capacity in the Performance Table (kcal/h)
- F: Correction Factor Based on the Equivalent Piping Length

Correction Factor for **Heating Capacity** according to Piping Length

The heating capacity should be corrected according to the following formula:

$$HCA = HC \times F$$

- HCA: Actual Corrected Heating Capacity (kcal/h)
- HC: Heating Capacity in the Performance Table (kcal/h)
- F: Correction Factor Based on the Equivalent Piping Length

The correction factors are shown in the following figure.

Equivalent Piping Length for:

- One 90° Elbow is 0.5m.
- One 180° Curve is 1.5m.

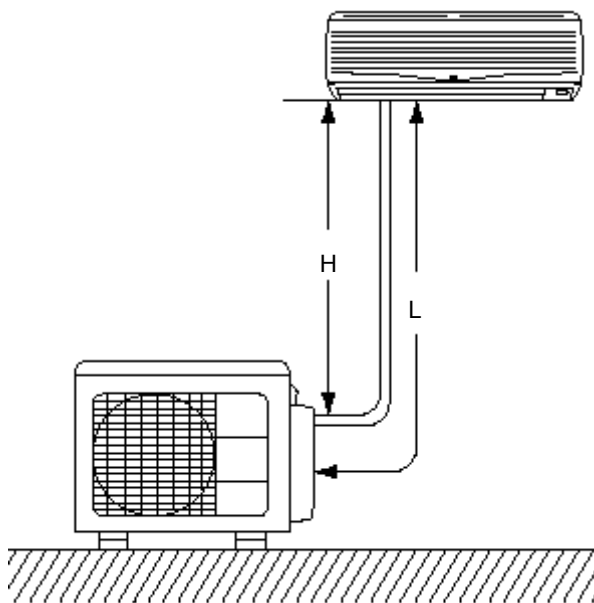

- H: Vertical Distance Between Indoor Unit and Outdoor Units in Meters
- L: Actual One-Way Piping Length Between Indoor Unit and Outdoor Unit in Meters
- EL: Equivalent Total Distance Between Indoor Unit and Outdoor Unit in Meters (Equivalent One-Way Piping Length)

Models : RAK-DJ18RHAE/RAC-DJ18WHAE, RAK-DJ25RHAE/RAC-DJ25WHAE, RAK-DJ35RHAE/RAC-DJ35WHAE

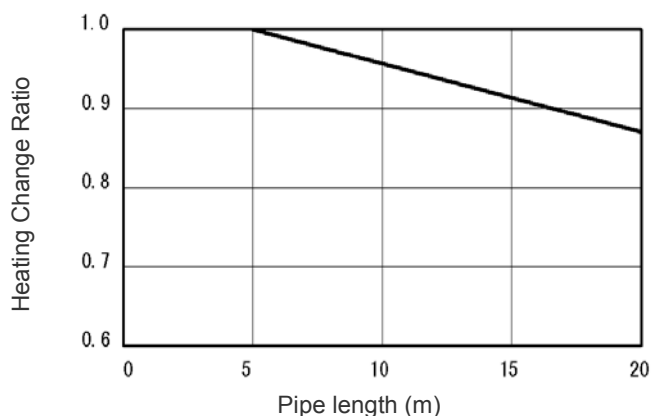
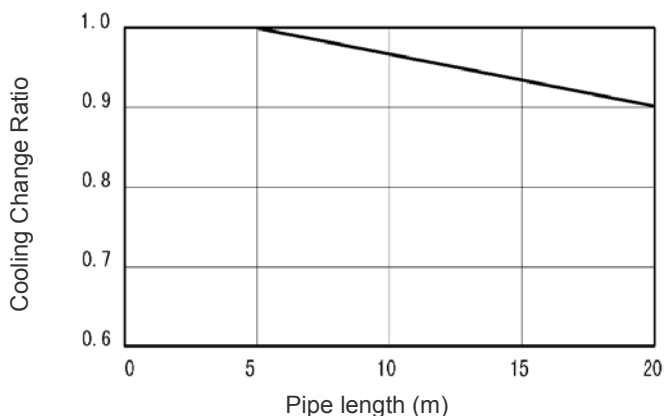

Models : RAK-DJ50RHAE/RAC-DJ50WHAE

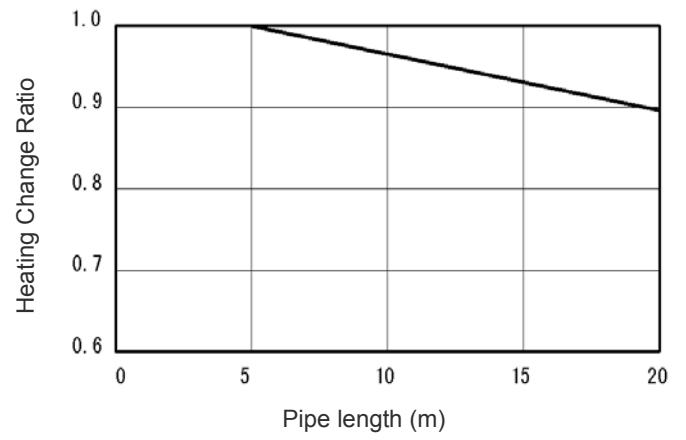
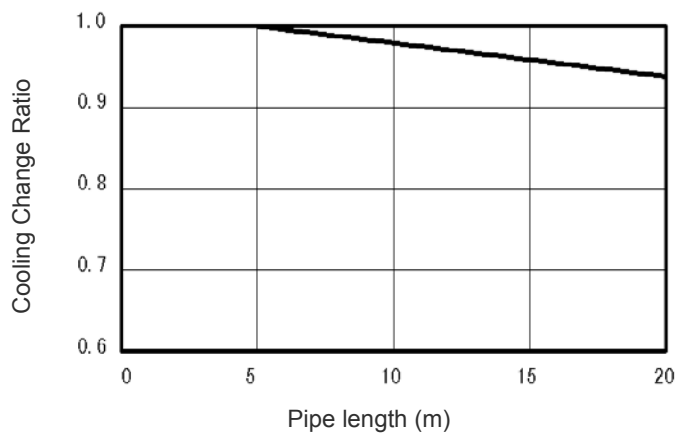

3.3. CORRECTION FACTORS ACCORDING TO DEFROSTING OPERATION

The heating capacity in the preceding paragraph, excludes the condition of the frost or the defrosting operation period. In consideration of the frost or the defrosting operation, the heating capacity is corrected by the equation below.

$$\text{Corrected heating capacity} = \text{Defrost Correction factor} \times \text{unit capacity}$$

OUTDOOR TEMPERATURE (°CDB)	-15	-10	-5	0	7	10	15
Correction factor (humidity rate 85% RH)	0.80	0.80	0.80	0.80	1.0	1.0	1.0

Correction Factor

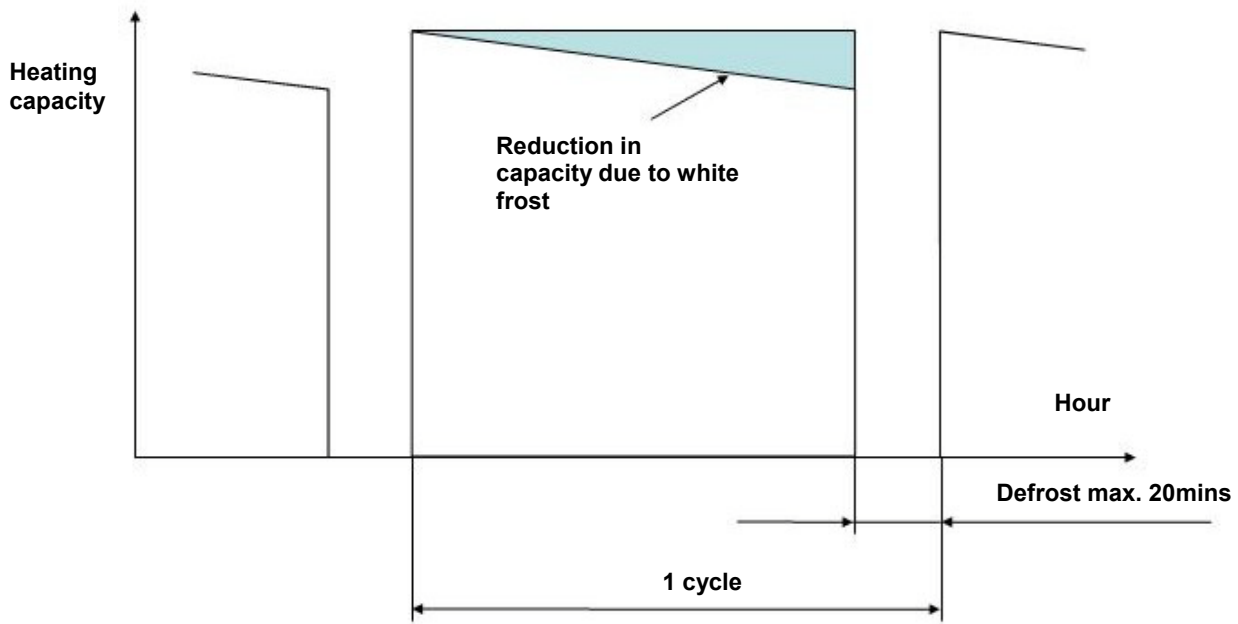

NOTE:

The correction factor is not valid for special conditions such as snowfall or operation in a transitional period.

4 SOUND DATA

4.1. RAC-DJ18WHAЕ

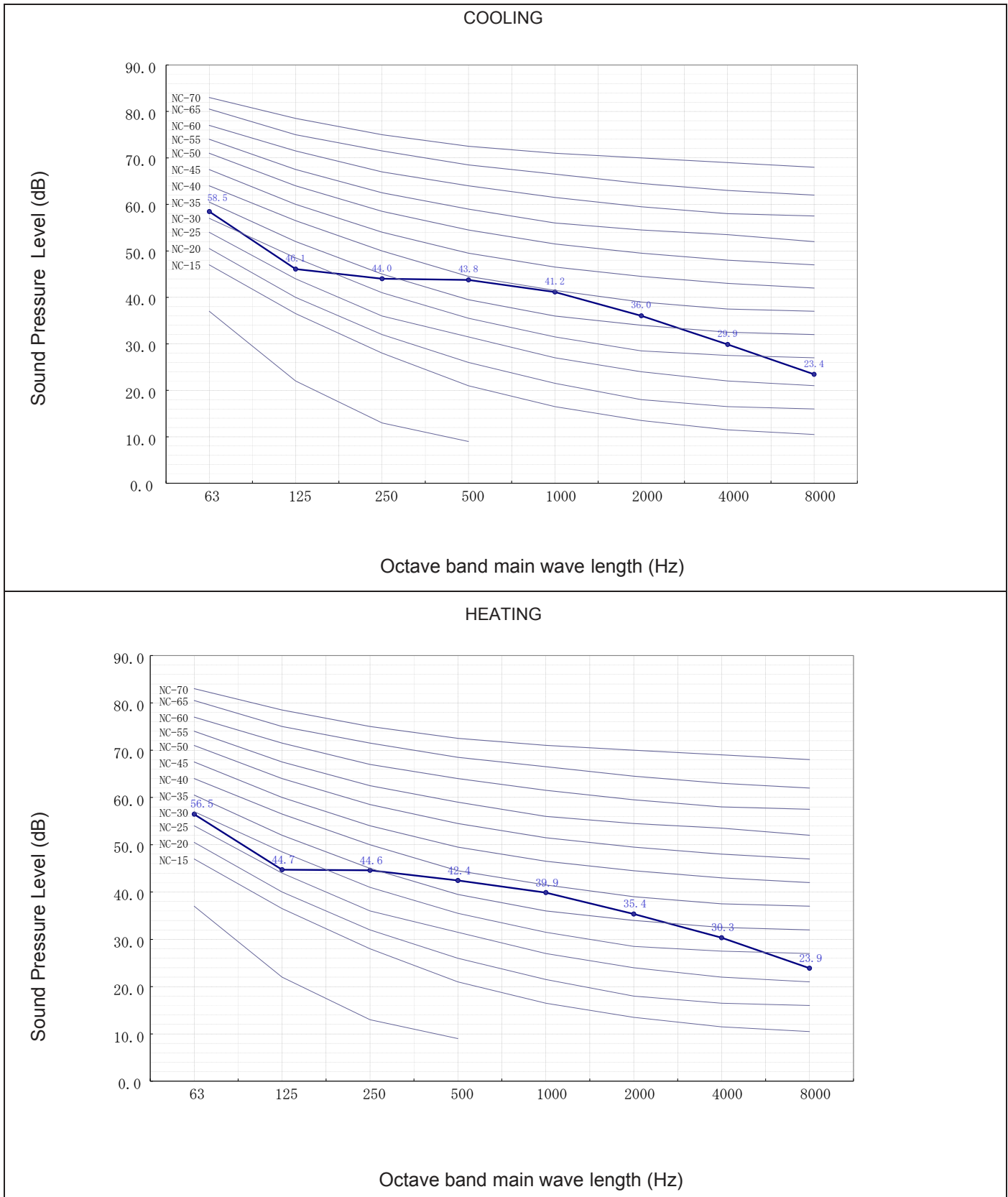

The Sound Pressure Level is based on the following conditions:

1 meter from the unit front surface and 1 meter from floor level

The above data was measured in an anechoic chamber. Please take into consideration reflected sound of your specific site

4.2. RAC-DJ25WHAЕ

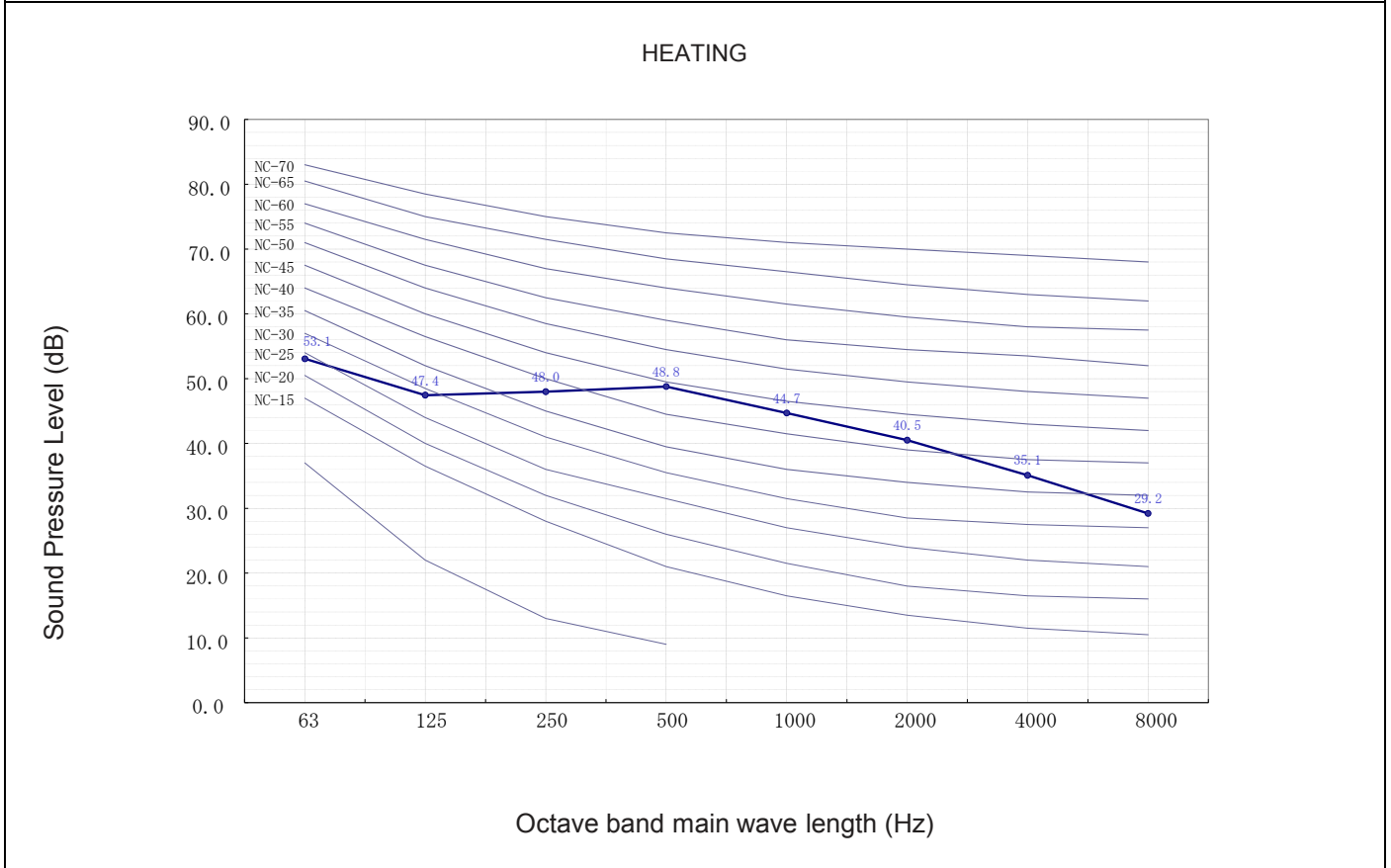
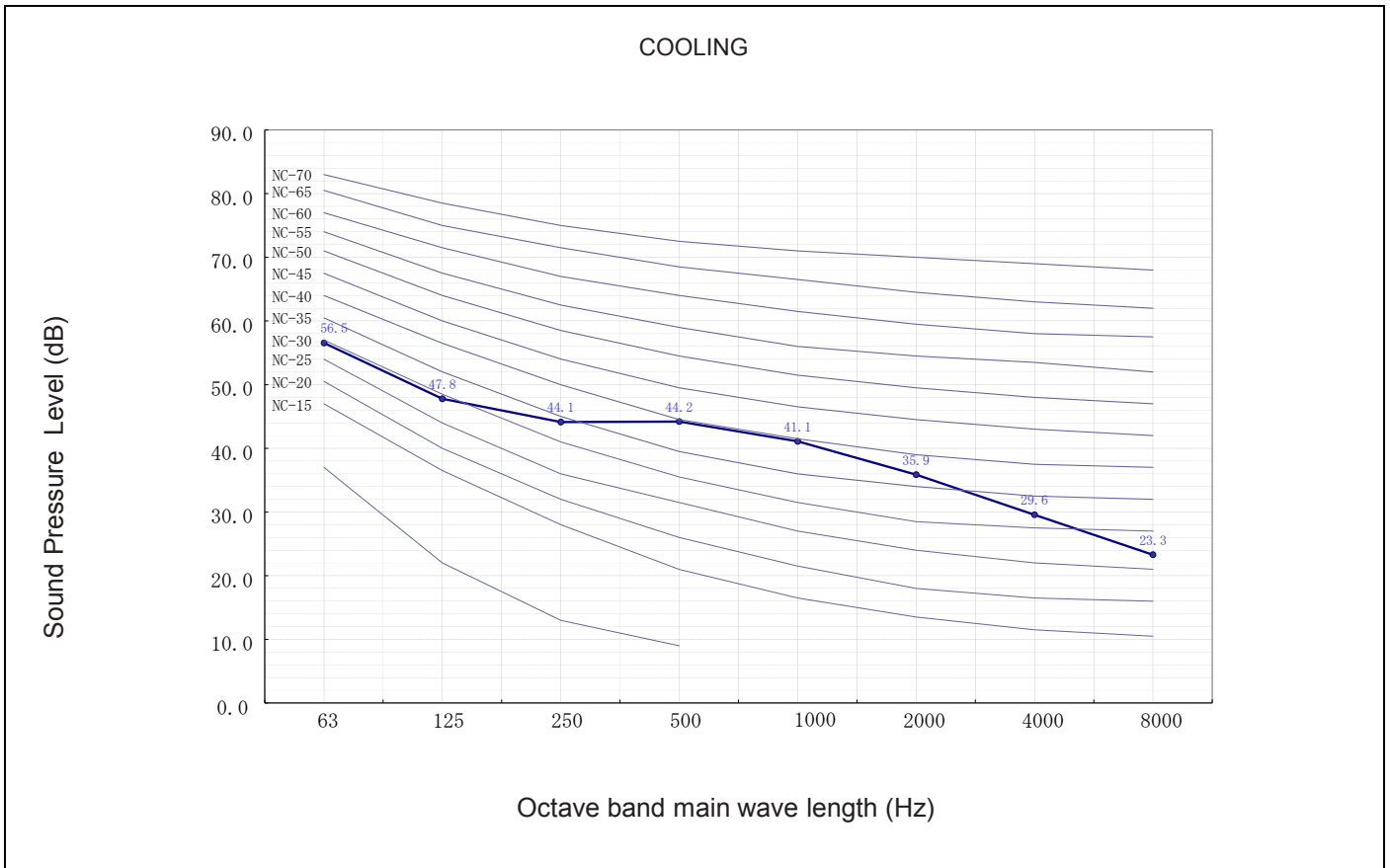

The Sound Pressure Level is based on the following conditions:

1 meter from the unit front surface and 1 meter from floor level

The above data was measured in an anechoic chamber. Please take into consideration reflected sound of your specific site

4.3. RAC-DJ35WHAЕ

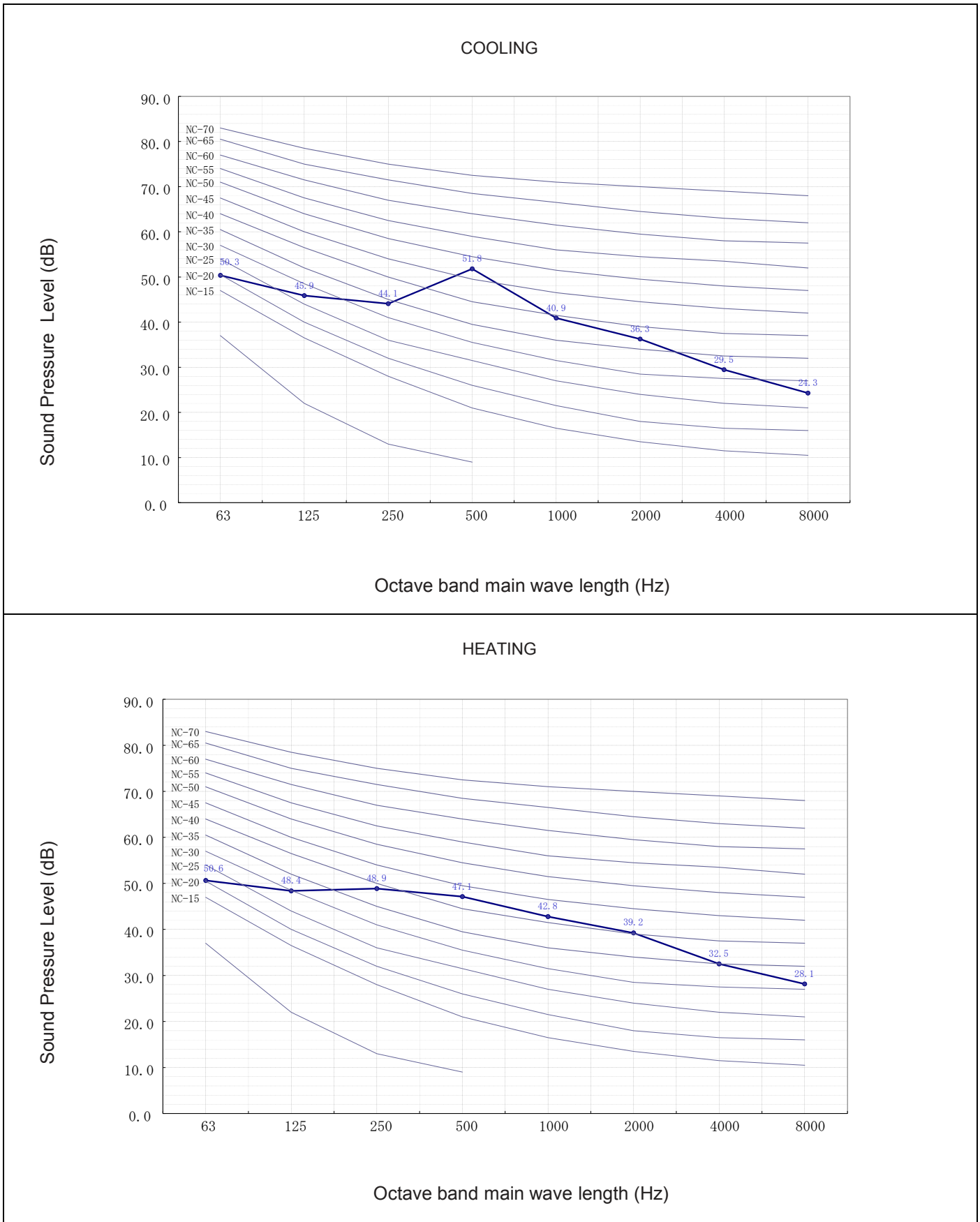

The Sound Pressure Level is based on the following conditions:

1 meter from the unit front surface and 1 meter from floor level

The above data was measured in an anechoic chamber. Please take into consideration reflected sound of your specific site

4.4. RAC-DJ50WHAЕ

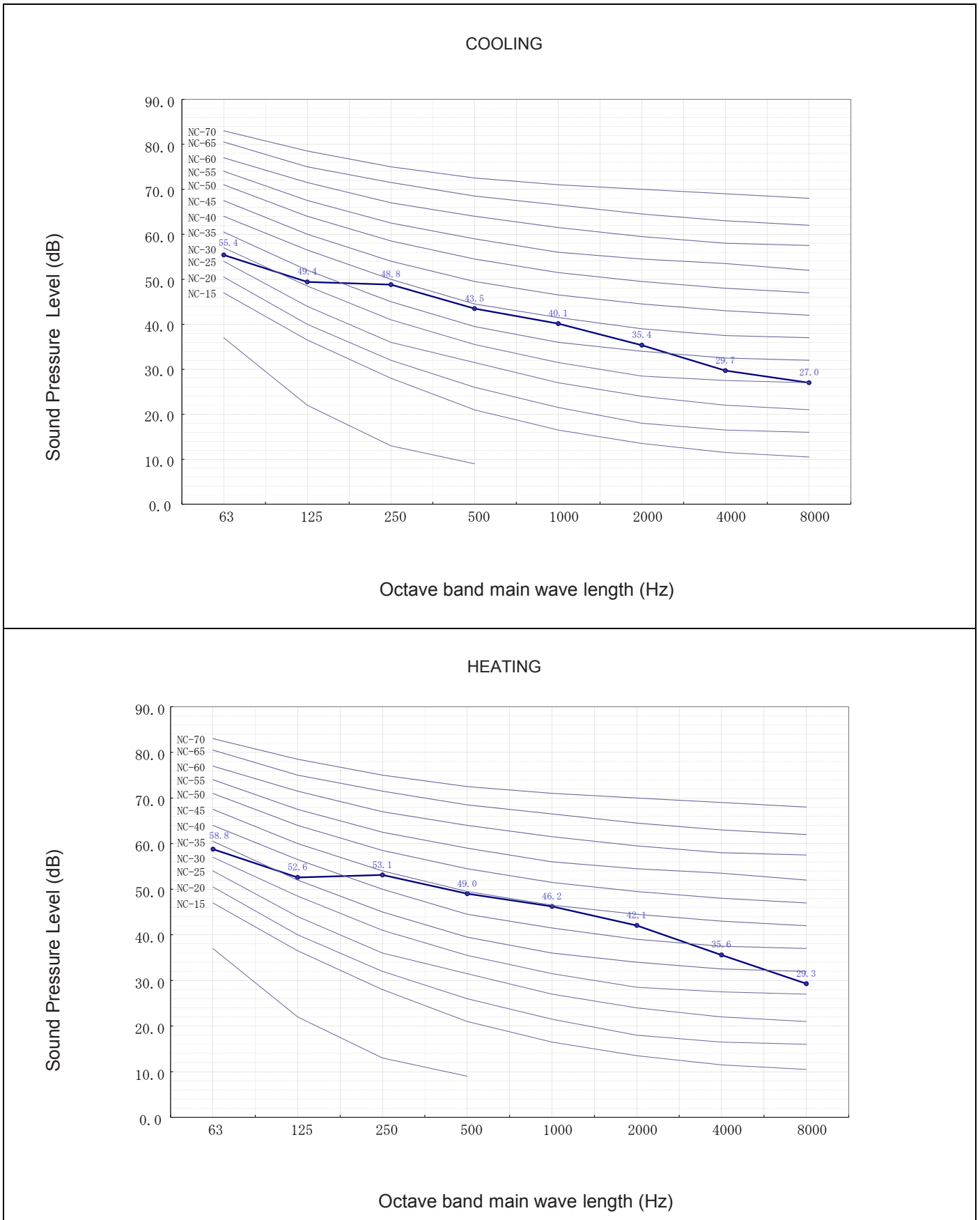

The Sound Pressure Level is based on the following conditions:

1 meter from the unit front surface and 1 meter from floor level

The above data was measured in an anechoic chamber. Please take into consideration reflected sound of your specific site

5 WORKING RANGE

5.1. POWER SUPPLY

Working Voltage	198V ~ 269V
Voltage Imbalance	Within a 3% Deviation from Each Voltage at the Main Terminal of Outdoor Unit
Starting Voltage	Higher than 85% of the Rated Voltage

5.2. WORKING RANGE

Applicable models:

RAC-DJ18WHAE
RAC-DJ25WHAE
RAC-DJ35WHAE
RAC-DJ50WHAE

The temperature range is indicated in the following table.

Cooling

working range	min (°C)	max (°C)	rated (°C)
outdoor	-10	46	35
indoor	16	32	27

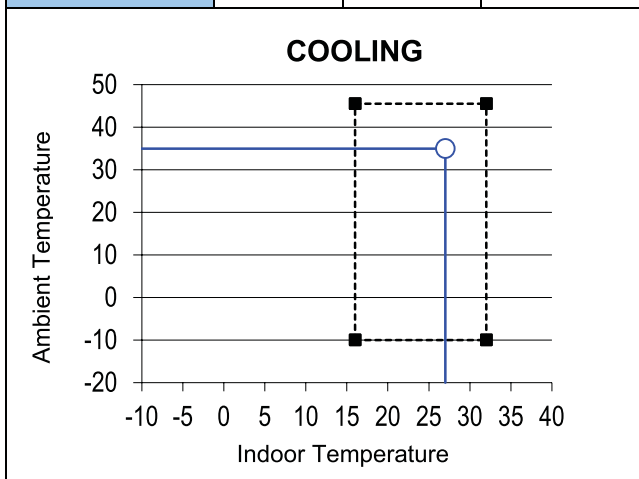

Heating

working range	min (°C)	max (°C)	rated (°C)
outdoor	-15	21	7
indoor	16	26	20

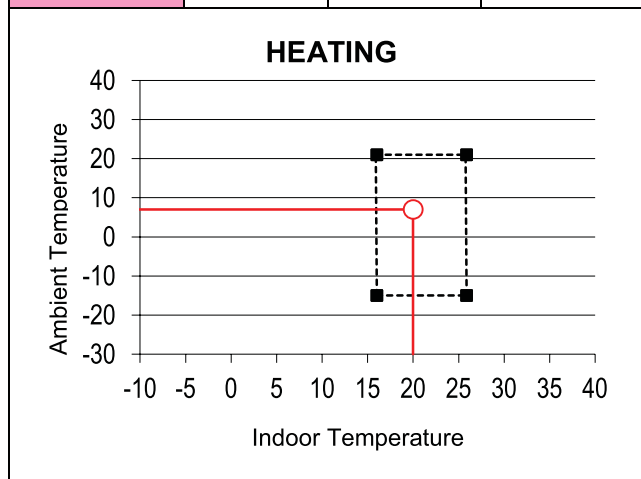

6 ELECTRICAL DATA

6.1. INDOOR UNIT

Model	Unit Main Power		Indoor Fan Motor	
	VOL, PH, Hz	Fuse Rating (A)	RNC	IPT
RAK-DJ18RHAE	220 ~ 240, 1, 50	3.15	(C)0.02 (H)0.03	(C)8.5 (H)11.0
RAK-DJ25RHAE	220 ~ 240, 1, 50	3.15	(C)0.04 (H)0.06	(C)11.8 (H)16.2
RAK-DJ35RHAE	220 ~ 240, 1, 50	3.15	(C)0.05 (H)0.09	(C)14.1 (H)22.9
RAK-DJ50RHAE	220 ~ 240, 1, 50	3.15	(C)0.06 (H)0.09	(C)19.4(H)26.1

VOL: Rated Unit Power Supply Voltage (V)
 Hz: Frequency (Hz)
 STC: Starting Current (A)

RNC: Running Current (A)
 PH: Phase (ϕ)
 IPT: Input (W)

6.2. OUTDOOR UNIT

Model	Unit Main Power		Applicable Current		Outdoor Fan Motor	
	VOL, PH, Hz	Fuse Rating (A)	STC	RNC	RNC	IPT
RAC-DJ18WHAE	220 ~ 240, 1, 50	15	(C)3.22 (H)3.51	(C)4.39 (H)4.22	(C)0.1 (H)0.1	(C)29.4 (H)29.4
RAC-DJ25WHAE	220 ~ 240, 1, 50	15	(C)3.89 (H)4.53	(C)5.61 (H)5.43	(C)0.17 (H)0.13	(C)42.2 (H)35.4
RAC-DJ35WHAE	220 ~ 240, 1, 50	15	(C)5.38 (H)5.30	(C)6.35 (H)7.39	(C)0.13 (H)0.15	(C)35.4 (H)39.4
RAC-DJ50WHAE	220 ~ 240, 1, 50	25	(C)7.11 (H)7.42	(C)9.13 (H)11.96	(C)0.20 (H)0.26	(C)52.6(H)63.2

VOL: Rated Unit Power Supply Voltage (V)
 HZ: Frequency (Hz)
 STC: Starting Current (A)

RNC: Running Current (A)
 PH: Phase (ϕ)
 IPT: Input (W)

NOTE:

1. The above compressor data is based on 100% capacity combination of indoor units at the rated operating frequency
2. This data is based on the same conditions as the nominal heating and cooling capacities.
3. The compressor started by an inverter, resulting in extremely low starting current.

7 WIRING DIAGRAM

7.1. RAK-DJ18/25/35/50RHAE

WIRING DIAGRAM

BLK:BLACK YEL:YELLOW
 BLU:BLUE GRN:GREEN
 RED:RED WHT:WHITE
 GRY:GRAY BRN:BROWN

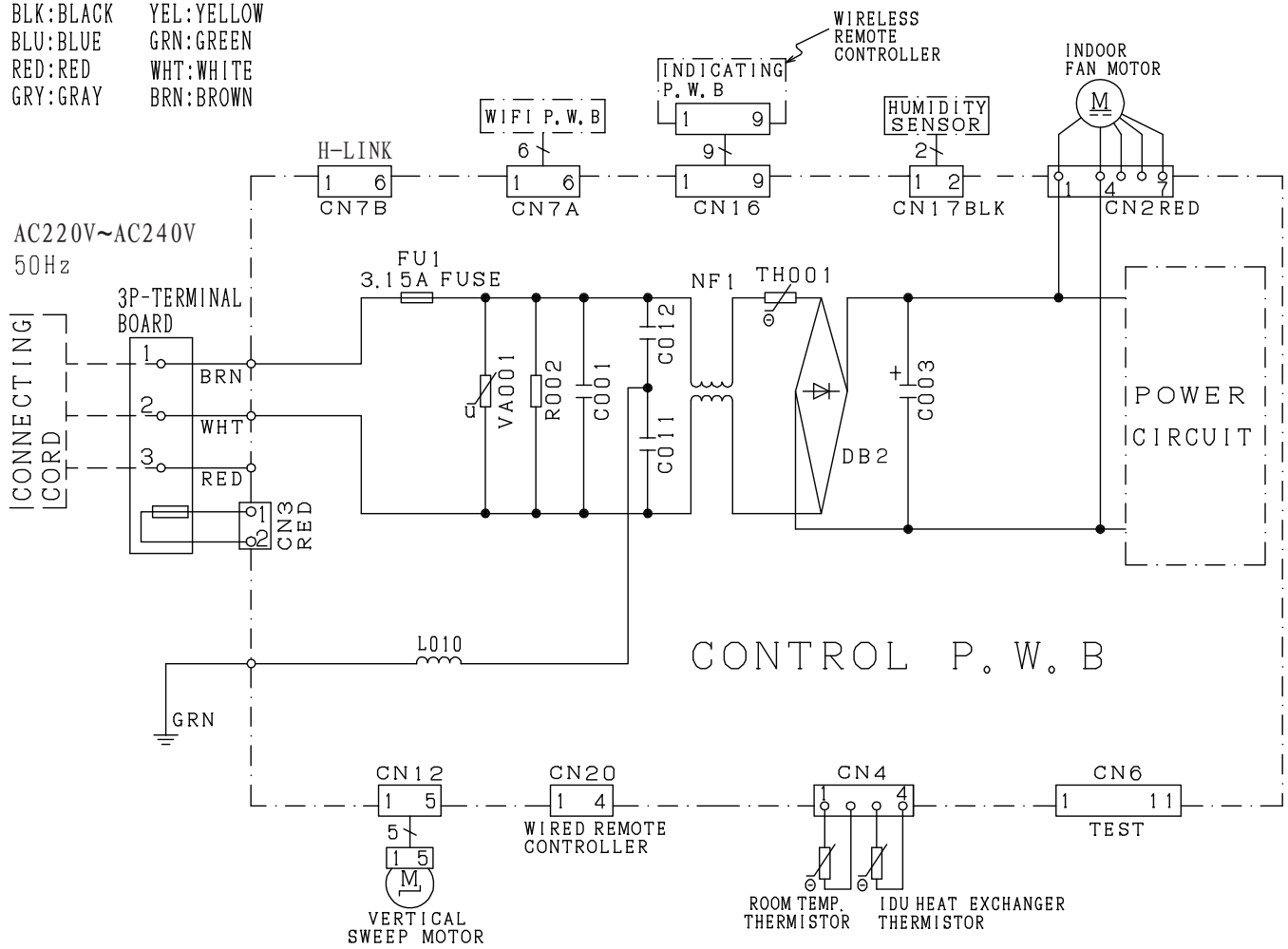

CAUTION! HIGH VOLTAGE	TURN OFF THE POWER SOURCE DURING THE SERVICE WORK.
--------------------------	---

7.2. RAC-DJ18/25/35/50WHAE

[WIRING DIAGRAM]

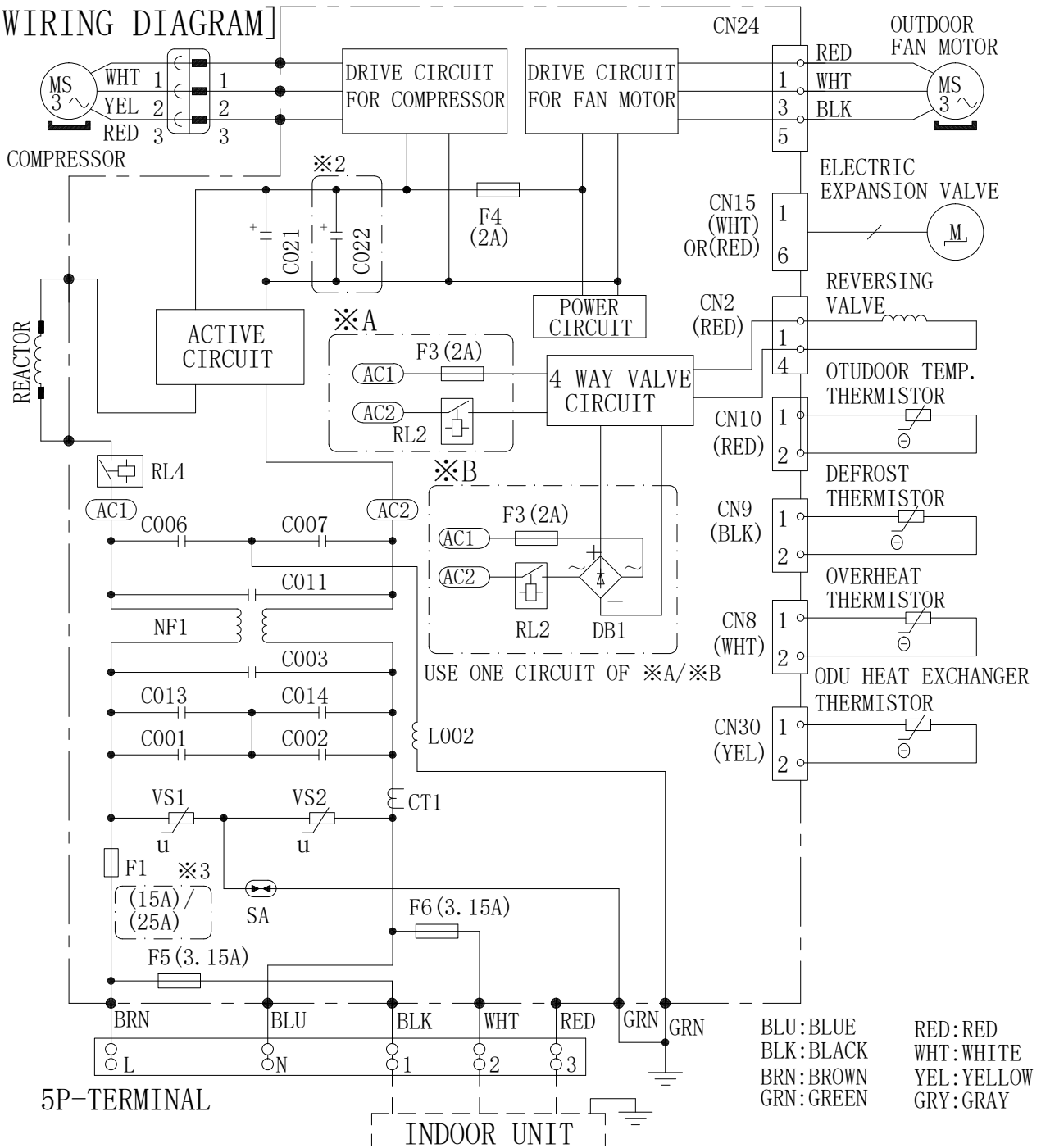

※2 SOME MODELS NOT NEED TO INSTALL THE CIRCUITS IN DASH DOT.
 ※3 F1 CURRENT VALUE BE DIFFERENT FOR DIFFERENT MODELS.

8 REFRIGERANT CYCLE

8.1. WALL TYPE: RAK-DJ18RHAE/RAC-DJ18WHAE, RAK-DJ25RHAE/RAC-DJ25WHAE

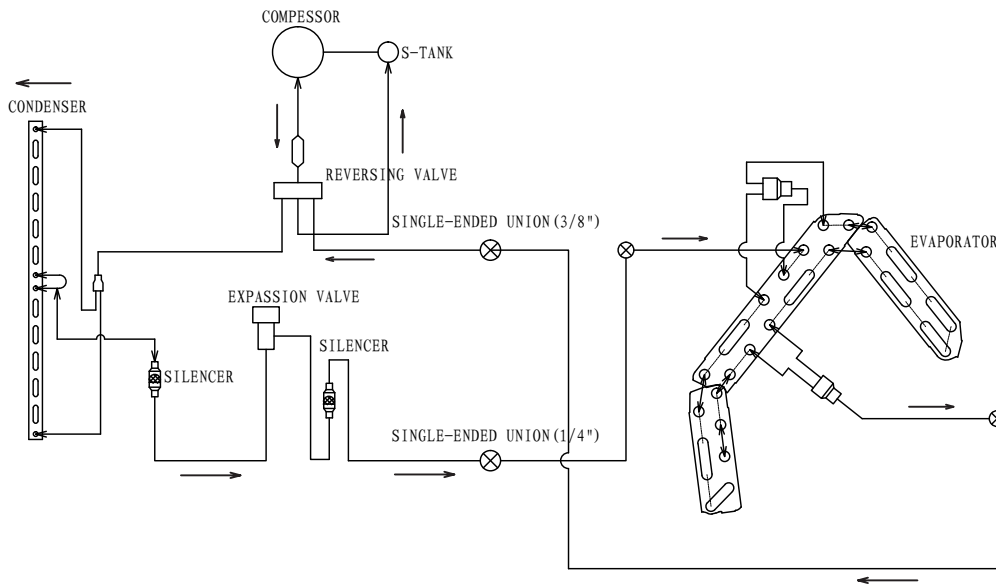

8.2. WALL TYPE: RAK-DJ35RHAE/RAC-DJ35WHAE

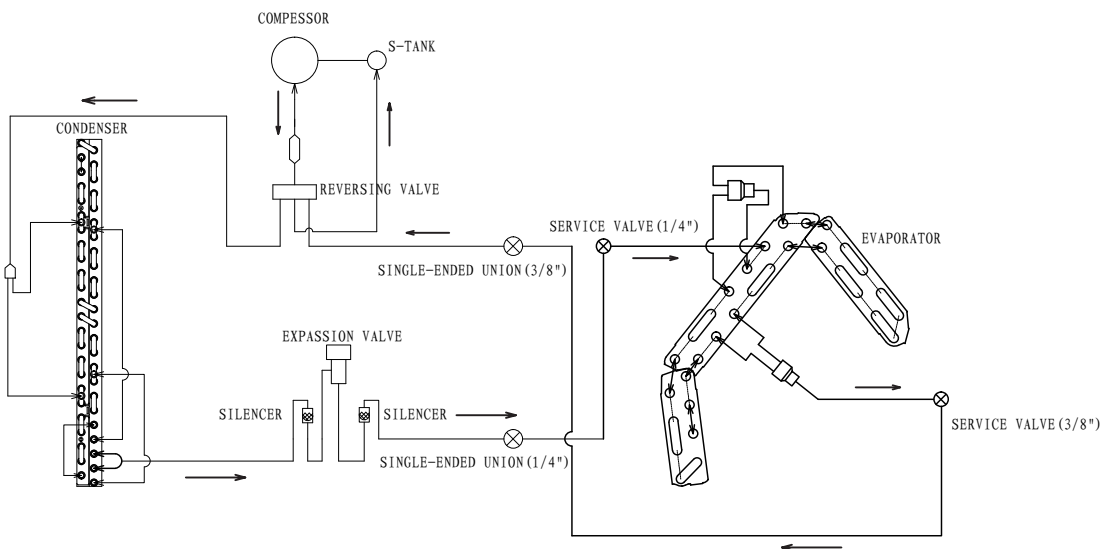



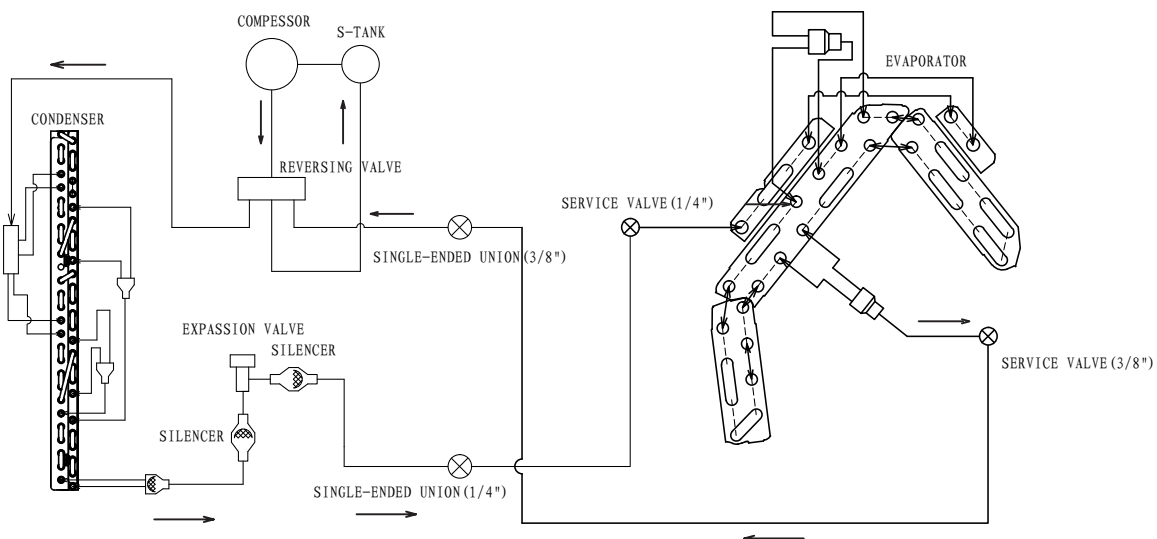





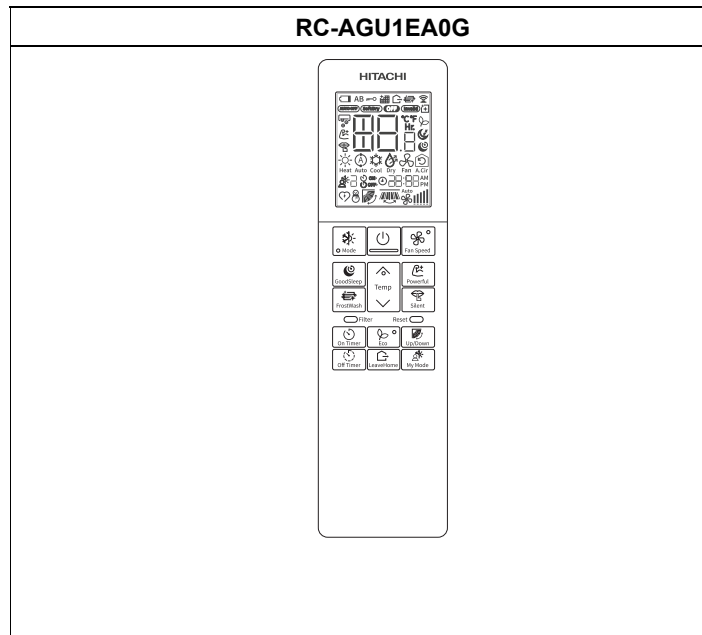









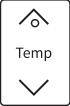

8.3. WALL TYPE: RAK-DJ50RHAE/RAC-DJ50WHAE



9 CONTROL AND FUNCTION

9.1. RC-AGU1EA0G



BUTTONS	FUNCTION
	Mode Selector Button Use this button to select the operation mode. Every time you press this button the mode will change from  (Heat) →  (Auto) →  (Cool) →  (Dry) →  (Fan) cyclically.
	GoodSleep Button the unit shifts the room temperature and reduces the fan speed.
	Temperature Button Room temperature setting. Value will change quicker when keep pressing.
	FrostWash Button The dust and dirt adhering to indoor heat exchanger which is the cause of the smell.
	Fan Speed Button Select the fan speed.
	On/Off Button Press this button to start operation. Press it again to stop operation.
	Powerful Button The air conditioner performs at maximum power.
	Silent Button The fan speed changes to the silent fan speed
	On Timer Button Select the turn ON time.
	Off Timer Button Select the turn OFF time.
	Eco Button Use this button to set the Eco mode.
	LeaveHome Button Prevent the room temperature from falling too much by setting temperature 10°C~16°C when no one is at home.
	Up/Down Button Control the angle of the horizontal air deflector.
	My Mode Button Use this mode for personalized comfortable settings. The My Mode can be set by using the remote controller. Up to 3 programs can be set.

9.2. How to set up from Service setting mode

The Service function, which was set by DIP-SW setting or double pressing of the HHRC in the current model. it will be done by HHRC in GRAC as shown as below.

[On timer] + [Fan speed] + [Reset]
(Press three Key for 5 seconds to avoid access by User)

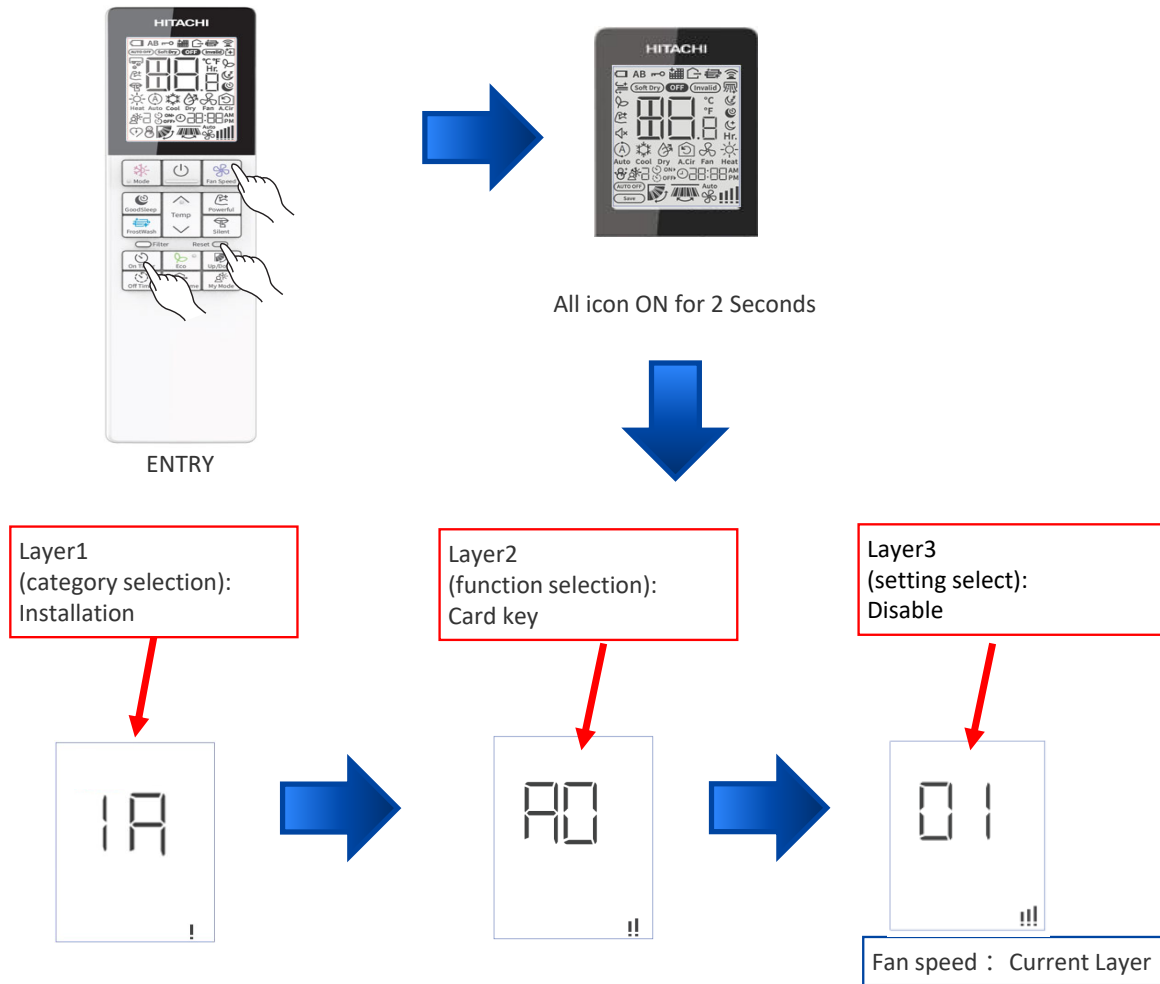

※ If you don't do anything for 30 seconds, you will be out of the service setting mode.

9.3. How to operate the HHRC method

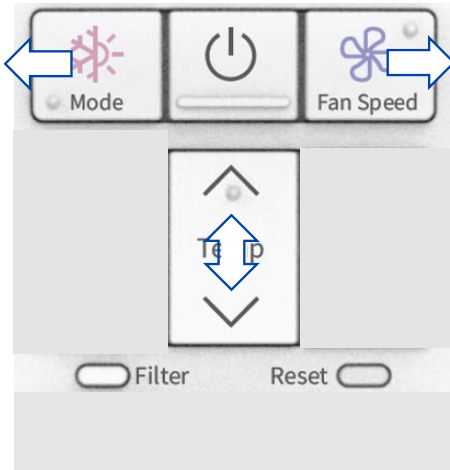

Temp Δ ∇ : Selection (in the same layer)
 Mode : move to previous layer
 Fan Speed : Move to next layer
 ON/OFF : Decision/Send (at layer 3)
 : Current setting check(at layer 2)
 Filter: category initialization(at layer 1)
 Filter + ON/OFF: all category initialization(at layer 1)
 ※ To exit from this setting mode, you need to either not operate the HHRC panel for 30 seconds or press and hold the UP/Down key for 5 seconds.

Layer 1
(category selection)

Layer 2
(Function selection)

Layer 3
(Setting select)

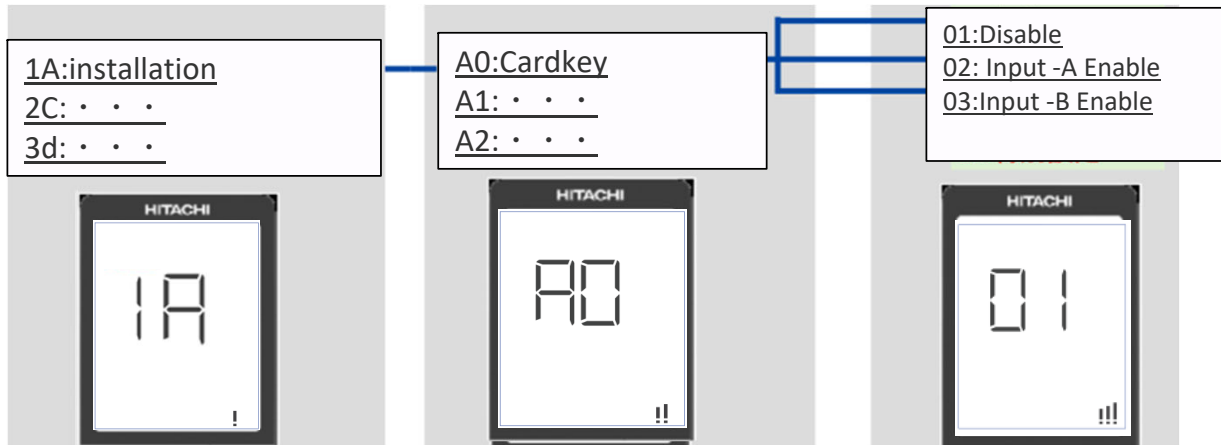

9.4. How to Adjust filter sign Time

The Adjust filter sign Time can be changed by the remote controller.
 (This procedure shall be implemented strictly by service personnel only.)
 It is possible to return it to the default setting.

Category	Function Name	Value	HHRC LCD display		
			Layer1 Category	Layer2 Function	Layer3 Value
Clean	Time for filter sign display	filter lamp lighting time:Adjustment -1(100h)	2C	C1	01
		filter lamp lighting time:Adjustment \pm 0(200h)			02
		filter lamp lighting time:Adjustment \pm 1(300h)			03
		filter lamp lighting time:Adjustment \pm 2(400h)			04
		reserve			05-99

Layer 1
(category selection)

Layer 2
(Function selection)

Layer 3
(Select settings)

1A: . . .	C0: Outdoor Frost wash	01:
2C: . . .	C1: Time for filter sign display	02:
3d: . . .	C2: IDU auto FrostWash period adjustment	03:
		04:



【IDU response】
 Buzzer sound: "pi"
 Timer LED: lit for 3s(only for "1A" category)
 Louver etc.: initializing operation

【note】
 If receiving the order of "05"- "99", IDU buzzer sounds as "pipi-"(rejecting sound).

9.5. Service setting item used for GRAC Entry

Category	Function	Display on LCD Temperature 7 segment Layer Wise			Value setting meaning at Layer-3
		1	2	3	
Installation	Card Key	1A	A0	01	1 - Card Key Input - Disable
				02	2 - Contact A Enable
				03	3 - Contact B Enable
				04-99	4~99 : Reserved
	Heating/Cooling only mode select - (Operation Mode Lock)	1A	A1	01	1 - Normal Mode
				02	2 -Cooling Lock (Cool,Dry,A.circulator,Fan mode available)
				03	3 - Heating Lock (Heat and Fan mode available)
				04-99	4~99 : Reserved
	Auto restart switchover(Standard)	1A	A2	01	auto restart changeover disable
				02	auto restart by previous mode
				03-99	3~99 : Reserved
	Clean	Time for filter sign display	2C	C1	01
02					filter lamp lighting time:Adjustment ±0 (200hours)
03					filter lamp lighting time:Adjustment +1 (300hours)
04					filter lamp lighting time:Adjustment +2 (400hours)
05-99					Reserved
Cycle Operation adjustment	Defrost selection Function	3d	E0	01	01 - Standard Region
				02	02- Cold Region
				03-99	Reserved
	Set temperature shift adjustment (Cooling)	3d	E1	01	Setting Temperature Shift Adjustment (-5°C/-10°F)
				02	Setting Temperature Shift Adjustment (-4°C/-8°F)
				03	Setting Temperature Shift Adjustment (-3°C/-6°F)
				04	Setting Temperature Shift Adjustment (-2°C/-4°F)
				05	Setting Temperature Shift Adjustment (-1°C/-2°F)
				06	Setting Temperature Shift Adjustment (±0°C/±0°F)
				07	Setting Temperature Shift Adjustment (+1°C/2°F)
				08	Setting Temperature Shift Adjustment (+2°C/4°F)
				09	Setting Temperature Shift Adjustment (+3°C/6°F)
				10	Setting Temperature Shift Adjustment (+4°C/8°F)
				11	Setting Temperature Shift Adjustment (+5°C/10°F)
	12-99	Reserved			
	Set temperature shift adjustment (Heating)	3d	E2	01	Setting Temperature Shift Adjustment (-5°C/-10°F)
				02	Setting Temperature Shift Adjustment (-4°C/-8°F)
				03	Setting Temperature Shift Adjustment (-3°C/-6°F)
				04	Setting Temperature Shift Adjustment (-2°C/-4°F)
				05	Setting Temperature Shift Adjustment (-1°C/-2°F)
				06	Setting Temperature Shift Adjustment (±0°C/±0°F)
				07	Setting Temperature Shift Adjustment (+1°C/2°F)
				08	Setting Temperature Shift Adjustment (+2°C/4°F)
				09	Setting Temperature Shift Adjustment (+3°C/6°F)
				10	Setting Temperature Shift Adjustment (+4°C/8°F)
				11	Setting Temperature Shift Adjustment (+5°C/10°F)
	12-99	Reserved			
Indoor fan air speed when cooling thermostat is off	3d	E3	01	01 : standard	
			02	02 : Cold Region	
			03-99	Reserved	
Selection of indoor fan control during heating thermo-off	3d	E4	01	01 : Fan Control at the Time of Heating Thermo- Off "Pattern 1"	
			02	02 : Fan Control at the Time of Heating Thermo- Off "Pattern 2"	
			03	03 : Fan Control at the Time of Heating Thermo- Off "Pattern 3"	
				d	
supporting service	Wi-Fi forced reset count	5F	L1	01	4(Number of forced resets)
				02	8(Number of forced resets)
				03	12(Number of forced resets)
				04-99	Reserved

9.6. Service setting item used for GRAC Entry

HHRC	Temperature Resolution change - 0.5°C--> 1°C	6H	P0	01	1 -0.5 °C Resolution 2-1 °C Resolution
	Fan Speed key sequence (Weaker to stronger , stronger to Weaker)	6H	P1	01	1 - Default (Auto-Silent-Low-Med-Hi-Hi2) 2- Reverse (Hi2-Hi-Med-Lo-Silent-Auto)
	Operation Mode : Auto	6H	P2	02	1-Disable Selection on HHRC by Mode key 2 - Enable Selection on HHRC by Mode Key
	Operation Mode : Cool	6H	P3	02	1-Disable Selection on HHRC by Mode key 2 - Enable Selection on HHRC by Mode Key
	Operation Mode : Dry	6H	P4	02	1-Disable Selection on HHRC by Mode key 2 - Enable Selection on HHRC by Mode Key
	Operation Mode : Fan	6H	P5	02	1-Disable Selection on HHRC by Mode key 2 - Enable Selection on HHRC by Mode Key
	Operation Mode : Heat	6H	P6	02	1-Disable Selection on HHRC by Mode key 2 - Enable Selection on HHRC by Mode Key
	Auto Fan speed : Enable / Disable	6H	P8	02	1 -Disable Selection on HHRC by Fan key 2 - Enable Selection on HHRC by Fan Key
	Fan Speed tapping control	6H	P9	01	1- Normal (Auto, Silent, Low, Med, Hi, H2) Selection on HHRC by Fan key 2- (Auto, Silent, Lo, Med, Hi) Selection on HHRC by Fan key
	Cooling Lower limit setting	6H	PC	16	(Lower set temp. start from 16 °C)
				17	(Lower set temp. start from 17 °C)
				18	(Lower set temp. start from 18 °C)
				19	(Lower set temp. start from 19 °C)
				20	(Lower set temp. start from 20 °C)
				21	(Lower set temp. start from 21 °C)
				22	(Lower set temp. start from 22 °C)
				23	(Lower set temp. start from 23 °C)
				24	(Lower set temp. start from 24 °C)
				25	(Lower set temp. start from 25 °C)
26				(Lower set temp. start from 26 °C)	
27				(Lower set temp. start from 27 °C)	
Heating Upper limit setting	6H	Pd	32	(Upper set temp. start from 32 °C)	
			31	(Upper set temp. start from 31 °C)	
			30	(Upper set temp. start from 30 °C)	
			29	(Upper set temp. start from 29 °C)	
			28	(Upper set temp. start from 28 °C)	
			27	(Upper set temp. start from 27 °C)	
			26	(Upper set temp. start from 26 °C)	
			25	(Upper set temp. start from 25 °C)	
			24	(Upper set temp. start from 24 °C)	
			23	(Upper set temp. start from 23 °C)	
			22	(Upper set temp. start from 22 °C)	
			21	(Upper set temp. start from 21 °C)	
20	(Upper set temp. start from 20 °C)				
19	(Upper set temp. start from 19 °C)				
18	(Upper set temp. start from 18 °C)				
17	(Upper set temp. start from 17 °C)				
16	(Upper set temp. start from 16 °C)				
Diagnosis	Failure Indication(latest to last 5 times)	7J	t0	01	1: Failure Display History 1 (Latest of last Five)
				02	2: Failure Display History 2
				03	3: Failure Display History 3
				04	4: Failure Display History 4
				05	5: Failure Display History 5 (5 th Error)
				06-99	Reserved
	display ODU Self check (Failure Diagnosis Start)	7J	t1	01	1 : Failure Diagnosis Start
				02-99	Reserved
	Failure Memory Erase	7J	t2	01	1:Failure Memory Erase
				02-99	Reserved
	Humidity Sensor failure diagnosis	7J	t3	01	1:Humidity ensor failure diagnosis request
				02-99	Reserved

9.7. Buzzer sounding for showing error contents

【Up/Down】
 (Press this Key for 5 seconds)

When IDU or ODU has failed, and the Timer lamp is blinking. Service engineer can know error contents from the buzzer through phone.

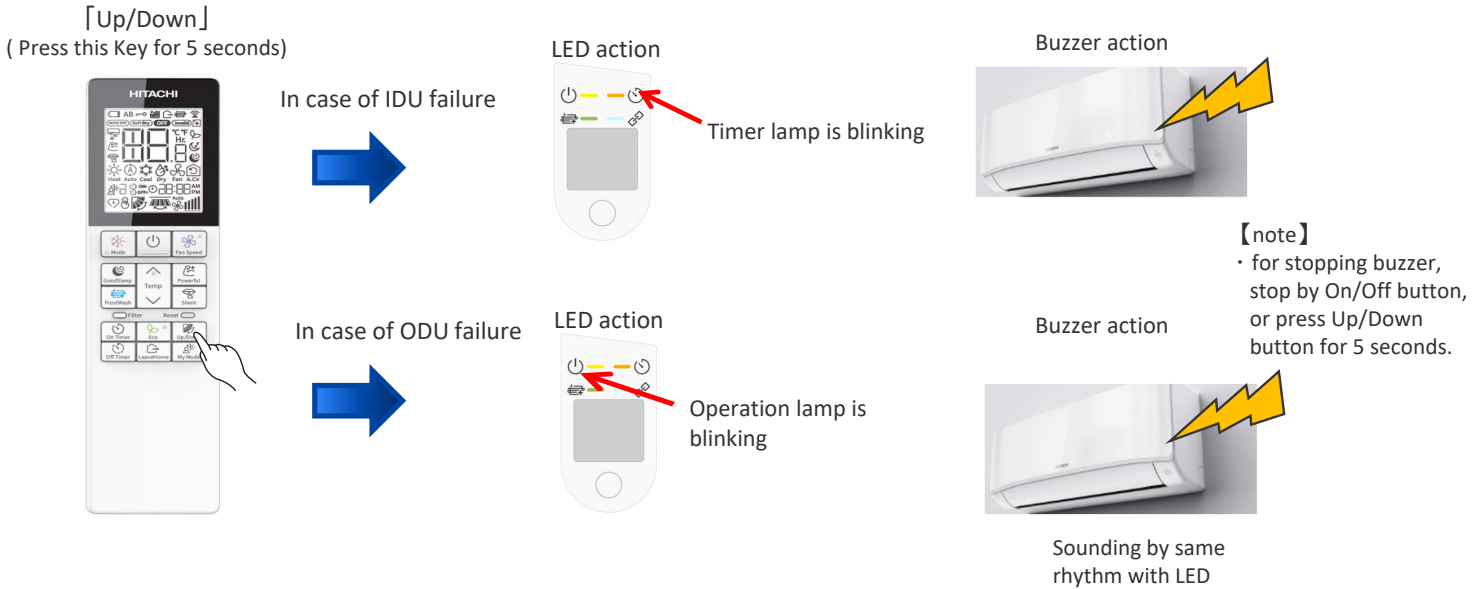

<IDU error example: timer LED will blink 3 times(interface defective(IDU) >

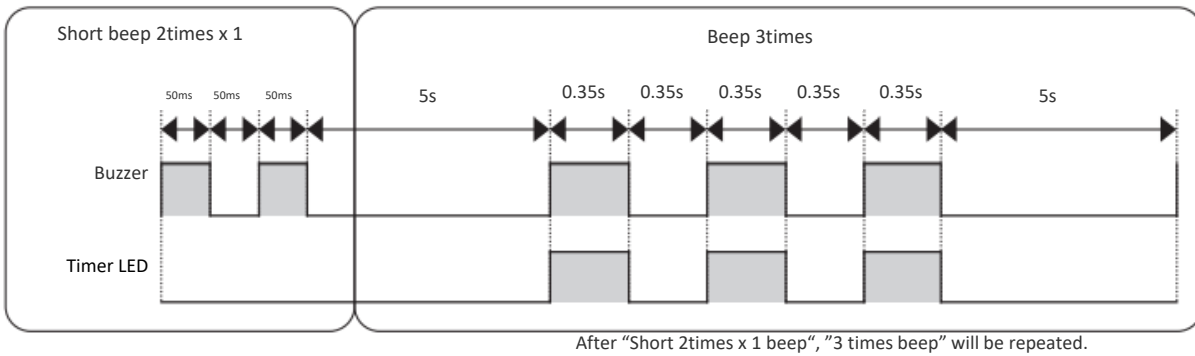

<ODU error example: operation LED will blink 2 times(peak current cut) >

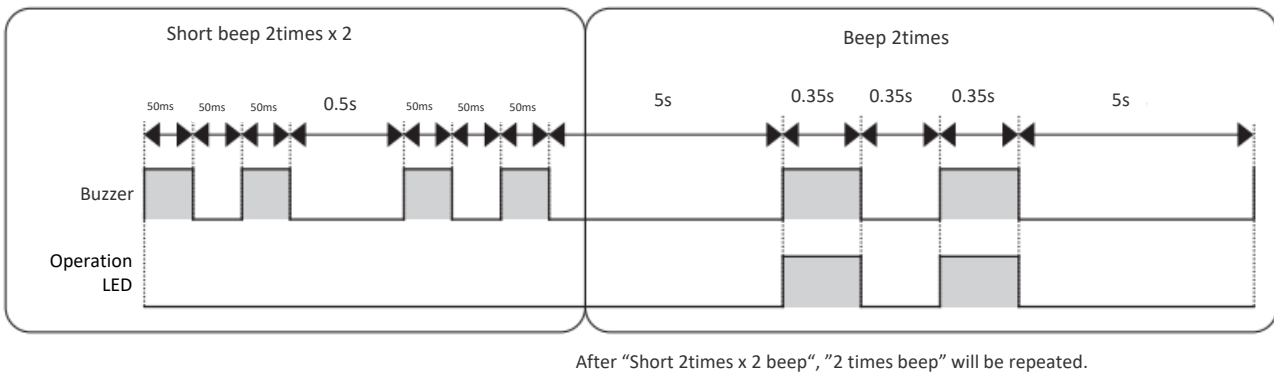

9.8. OTHER SETTING

▪ ID SELECTION

1. Press “Up/Down swing button” and “set. Temp. up button” and “reset button”, and release “reset button”.
2. Select from A or B by pressing “set.temp. button”.
3. Press “On/Off button” toward IDU.

(EEPROM in HHRC will keep the A or B information.)

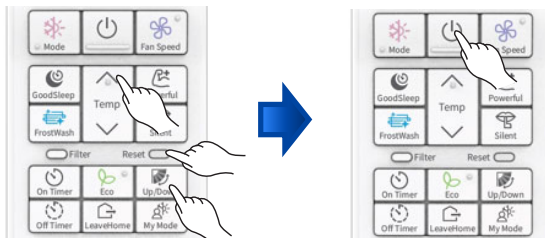

▪ DISPLAY MODE

For operating indoor unit independently (without outdoor unit connection), remote controller has to be set according to below procedures before send the signal to the indoor unit. New communication format between indoor and outdoor is required to communicate with outdoor unit.

1. Press and holding “On Times button” and “On/Off button”, press “reset button” on the same time.
2. Release “reset button” only and make sure that the FAN speed icon  on LCD display.
3. Press “On/Off button” toward IDU.

Then, the indoor unit will start to operate independently according to the selected operation mode.

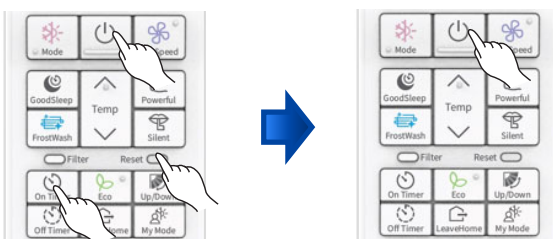



9.9. ERROR CODE INFORMATION

9.9.1. HOW TO DISPLAY ERROR CODE

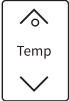
1. Press three key ([On Timer] + [Fan Speed] + [Reset]) button on the remote control for 5 seconds to avoid access by User.

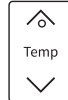
2. Press “” (Temperature) button of the remote control and select the “7J” option.

3. Press “” (Fan Speed) button of the remote control, then Press “” (Temperature) button select the “t0” option.

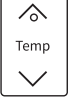
4. Press “” (Fan Speed) button of the remote control, then Press “” (Temperature) button select the “01” option.

5. Press “” (On/Off) button of the remote control, the fault information will be seen.

Function Name	Value	Layer1	Layer2	Layer3
		Category	Function	Value
Display self-diagnosis memory(※)	Display History 1 (Latest(newest) of last Five)	7J	t0	01
	Display History 2			02
	Display History 3			03
	Display History 4			04
	Display History 5			05

The specific information of error code is shown in the table below:

	TIMER LAMP BLINKING	LD301 BLINKING	CODE	MEANING
INDOOR	-	-	000 00	Normal
	1 time	-	001 00	Refrigerant cycle fault
	2 times	-	-	Outdoor unit is under forced operation
	3 times	9 times	003 00	Communication error (indoor)
	9 times	-	009 00	Indoor thermistor defective
	10 times	-	003 00	Abnormal rotating numbers of DC fan motor
	12 times	9 times	012 00	Communication error (outdoor)
	13 times	-	013 00	EEPROM data reading error
	20 times	-	020 00	Human sensor defective
	21 times	-	021 00	Interface defective (other machine cause)
	25 times	-	025 00	CN7A/B connection defective

	OPERATION LAMP BLINKING	CODE	MEANING (THE FOLLOW DEFECTIVES IN OUTDOOR?? UNIT)
INDOOR	2 times	002 01	Peak current cut
	3 times	003 01	Compressor abnormal low speed rotation
	4 times	004 01	Compressor switching failure
	5 times	005 01	Overload lower limit cut
	6 times	006 01	OH thermistor temperature rise
	7 times	007 01	Abnormal outdoor thermistor
	9 times	009 01	Communication error
	10 times	010 01	Abnormal power source
	11 times	011 01	Fan stop for strong wind
	12 times	012 01	Fan motor fault
	13 times	013 01	EEPROM reading error
	14 times	014 01	DC Voltage abnormal
	15 times	015 01	Abnormal PWB circuit
	16 times	016 01	High load stop

9.9.2. HOW TO REMOVE ERROR CODE

1. Press three key ([On Timer] + [Fan Speed] + [Reset]) button on the remote control for 5 seconds to avoid access by User.

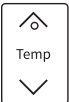
2. Press “” (Temperature) button of the remote control and select the “7J” option.

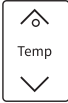
3. Press “” (Fan Speed) button of the remote control, then Press “” (Temperature) button select the “t2” option.

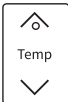
4. Press “” (Fan Speed) button of the remote control, then Press “” (Temperature) button select the “01” option.

5. Press “” (On/Off) button of the remote control, and the error code will be removed.

10 OPTION LIST

10.1. H-LINK ADAPTOR – PSC 6RAD

10.1.1. SAFETY SUMMARY

DANGER:

- DO NOT pour water into the remote control switch (hereafter called "controller"). This product is equipped with electrical parts. This will cause serious electrical shock.

WARNING:

- DO NOT perform installation work and electrical wiring connection by yourself. Contact your distributor or dealer of HITACHI and ask then for installation work and electrical wiring by service person. The specified cable should be used to connect (i) room air conditioner and adaptor, and (ii) controller and adaptor.



CAUTION:



- DO NOT install the indoor unit, outdoor unit, controller and cable as such places as:
 - where there is oil vapor and dispersion of oil
 - where there is sulfuric environment (near the hot springs)
 - where there is a flammable gas
 - where there is salty environment (near the sea)
- DO NOT install the indoor unit, outdoor unit, controller and cable within approximately 3 meters from strong electromagnetic wave radiators, such as medical equipment. In case that the controller is installed in a place where there is electromagnetic wave direct-radiation, shield the controller and cables by covering with the steel box and running the cable through the metal conduit tube.
- In case that there is electric noise at the power source for the indoor unit, provide a noise filter.

10.1.2. INSTALLATION WORK

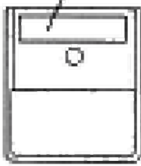
■ Before installation

Check the contents and the number of the accessories in the packing.

Adaptor	 With two 1.8m cables
1 piece of cover for hiding the covering	 Attached 2 sided tapes
Two-sided tape for attaching to Adaptor	 110x40x3mm

2 connectors for H-Link connection		
2 tapping screws for attaching to wall		φ3.0 x 10mm
2 screws for attaching to wooden wall		φ3.1 x 16mm

- 1) RAC adaptor can be installed to the wall as well as on the air conditioner itself
- 2) Install RAC adaptor in the vertical surface as shown below.

Upper side

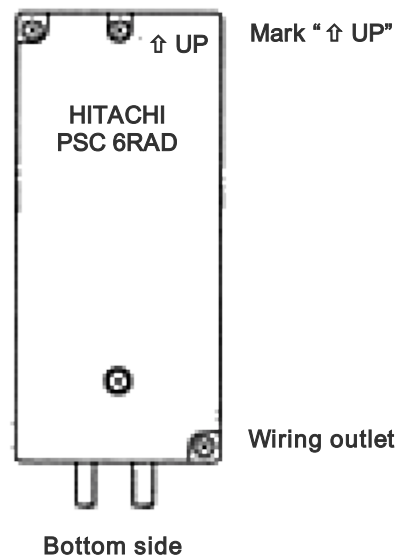

- 3) Installation procedure
 - a) When installing to the wall.
 - i) Fix the adaptor with 2 screws. Tapping screw is for metal surface, and other screw is for wooden surface.

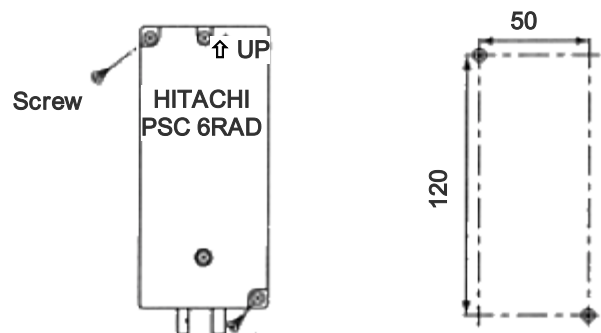

- ii) When using the cover
It can be installed at the right and left side of room air conditioner. Fix the cover and RAC adaptor with the two-sided tape (accessory).

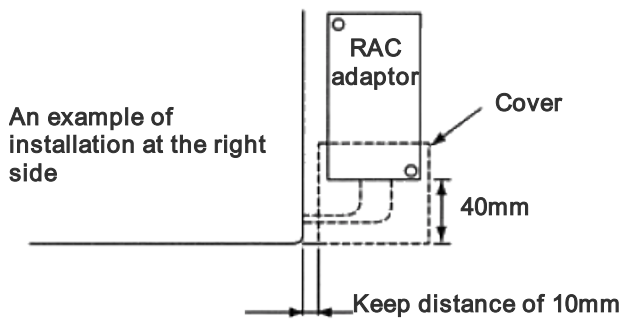

- b) When installing on the room air-conditioner
- In case that it cannot be installed to the wall due to the space or material problem, install the RAC adaptor with the two-sided tape (accessory) on the room air-conditioner.
- Confirm if the piping cover of the unit can be removed when performing the service maintenance, and then fix the RAC adaptor in the side of room air-conditioner with two-sided tape. (Available at the right as well as left side)
 - Clean the surface to be installed with a dry cloth.

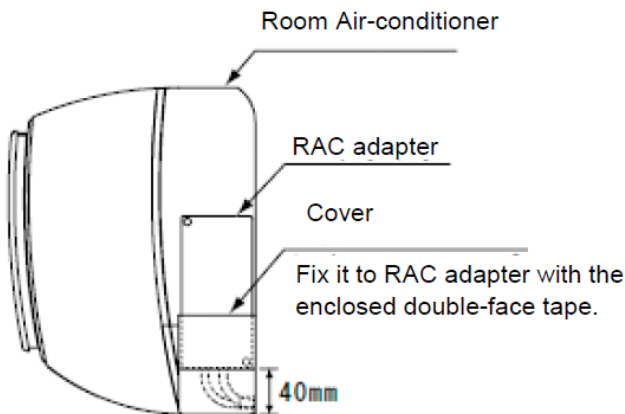

NOTE:

- Consider the following points since the adhesiveness changes according to the environmental conditions (temperature, humidity etc)
- The adhesiveness is decreased when there is humidity or oil.
- Warm the adhesive part and installation place of the two-sided tape to avoid the decrease of the adhesiveness in case the ambient temperature is low.
- DO NOT touch the adhesive part by fingers nor re-attach it many times. The adhesiveness has decreased and the RAC adaptor may fall off.
- DO NOT apply any force within 24 hours after installation.

10.1.3. ELECTRICAL WIRING

■ System configuration

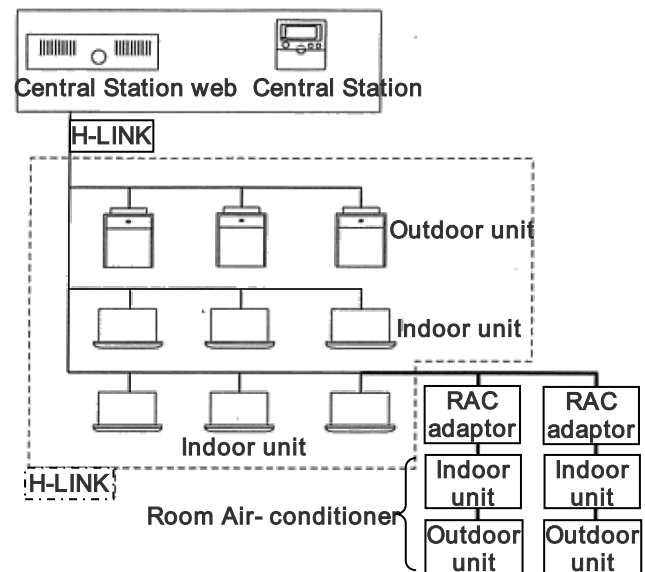

CAUTION:

- Turn OFF the power supply of the room air-conditioner of the central control device when performing the wiring work
- DO NOT run all the H-LINK cable or power supply cable along the other signal cable, or malfunction may occur due to the noise, etc. If it is required to run along the other transmission cable, separate the cable more than 30cm, or run the cable through the metal tube and earth the tube.
- Follow local codes and regulations when performing electrical wiring and earth wiring.
- Transmissions cable used in H-LINK shall be 2 cores cable (0.7mm^2 to 1.25mm^2 for model: VCTF, VCT, CVV, MVVX, CVVX, VVR, VVF) or 2 cores twisted pair cable (model: KPEV, KPEV-Spec). Total length of cable shall be below 1000mm.
- DO NOT use wire with more than 3 cores.

■ Internal components and Wiring connections

Check the contents and the number of the accessories in the packing.

- Access
Open the cover by removing the ① and ② screws.



- Wiring Connection
Connection with Room Air-Conditioner
 - Remove the front cover of the room air-conditioner and the cover of electrical box.
 - The cable attached with the connector of the RAC adaptor shall be connected with the connector of indoor PCB

- iii) Install the electrical box cover paying attention not to clamp the cable. Read the installation manual of each room air-conditioner for confirming how to connect and how to assemble the cable of the RAC adaptor.

CAUTION:

- Disconnect the power plug before performing this work
- Turn OFF the break power source in case the power is supplied from the outdoor unit.

- Connection of Transmission Cable

H-LINK transmission cable connecting to RAC adaptor shall be connected to H-LINK.

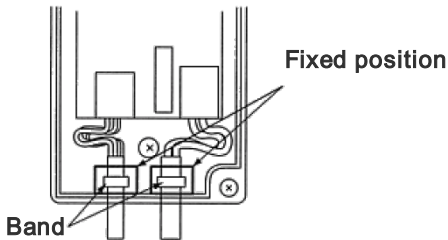
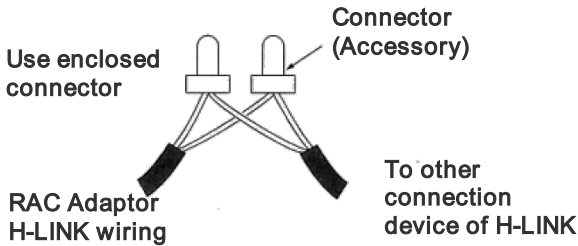

CAUTION:

- DO NOT connect incorrect wiring. It may cause the failure of the RAC Adaptor. Especially pay attention not to apply high voltage e.g. AC400/230V.
- DO NOT perform the wiring work while power to the central station or the RAC Adaptor is still being supplied. It may cause malfunction. Turn OFF devices when performing the wiring work.
- The RAC Adaptor side cable should not overload to the connector.
- DO NOT clamp the cable when attaching the RAC adaptor cover.
- Band should not be loose and in fixed position.

10.1.4. DIP SWITCH SETTING

- 1) Switch OFF the power of room air conditioner before setting the DIP switch. If the power is ON, the settings are INVALID.
- 2) The position of the DIP switch is shown below.

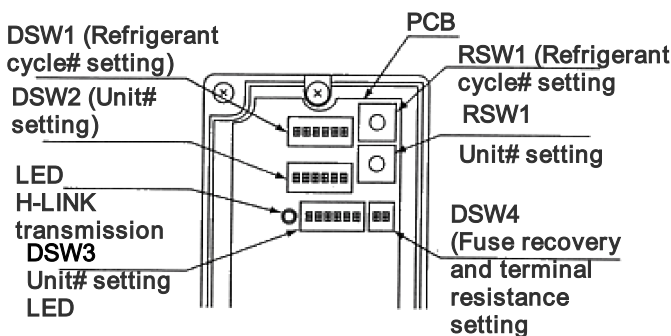

CAUTION:

- DO NOT turn ON various pins of DSW1 and DSW2

- 3) Set the refrigerant cycle# by RSW1 and DSW1

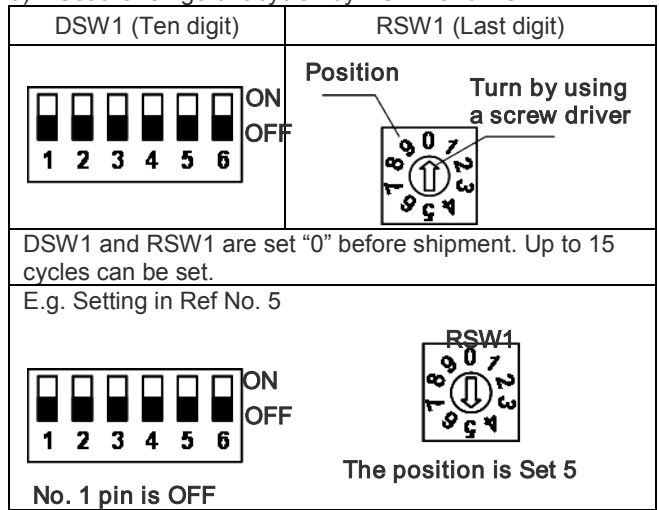

- 4) Set the unit No. by RSW2 and DSW2

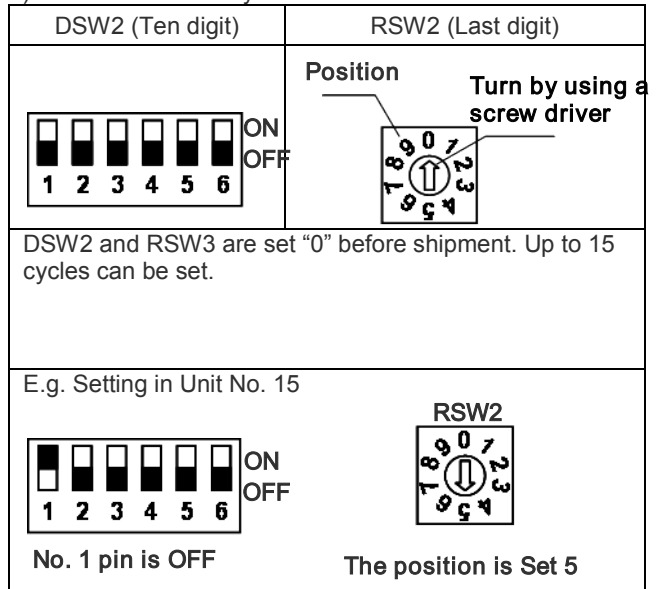

- 5) Slave unit.

In case of setting various RAC adaptors in the same refrigerant cycle, set the RAC adaptor with smallest Unit# as a master unit. In case of setting only one RAC adaptor in a refrigerant system, this adaptor should be a master unit. Set this procedure by DSW3.

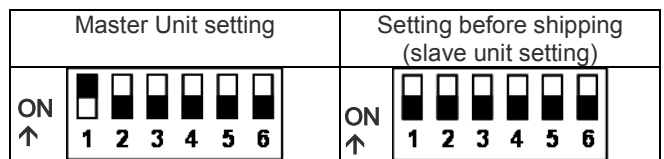

●: Master Unit setting

○: Setting before Shipping (Slave Unit setting)

		Indoor Unit#							
		0	1	2	3	4	5	6	7
Refrigerant Unit#	0	●	○	○	○	○			
	1			●	○	○			
	2				●	○	○	○	○
	3		●						
	4								

CAUTION:

- DO NOT set various main adaptors in the same refrigerant cycle.

- 6) Procedure when applying 200V voltage to H-LINK wiring incorrectly.

In case of applying 200V voltage to H-LINK wiring incorrectly, the fuse installed in a transmission circuit on PCB will blow out. In this case, reconnect the wiring correctly and turn ON No. 2 pin of DSW4 on PCB. The transmission circuit can be recovered. (If applying this error again, the transmission circuit can not be recovered)

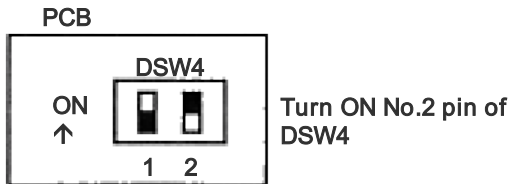

- 7) Terminating resistance is set in whole H-LINK system.
 - a) If H-LINK connecting devices like package air-conditioner are connected besides the RAC Adaptor, set the terminating resistance by those connecting devices. The terminating resistance should be set ON in only one position in whole H-LINK system.
 - b) In case that H-LINK is connected only by the RAC adaptor, set the terminating resistance by the RAC adaptor. The terminating resistance should be set ON in only one position in whole H-LINK system.

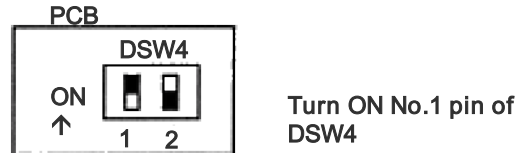

10.1.5. TEST RUN

Test run should be performed in the following after finishing the installation, wiring and setting. Refer to the installation manuals enclosed with the control system equipment.

- 1) Confirmation of RAC Adaptor Connection

Confirm if the RAC adaptor connection is recognized in the control system equipments. In case that it is not confirmed, check the transmission cable, refrigerant cycle #, indoor unit #, terminal resistance setting etc.
- 2) Registration

Confirm if the RAC adaptor connection is recognized.
- 3) Confirmation of RUN/STOP Operation.

Confirm if the room air-conditioner operate correctly by RUN/STOP from the central control system equipments. Check also if the room air-conditioner operation changes correctly by each setting.

10.2. DRY CONTACT (SPX-WDC3) APPLICATION

The dry contact system enables the operation of the air conditioner indoor unit to be controlled by using external dry contacts (with non voltage) such as card-key controller or window for facilities such as hotels.

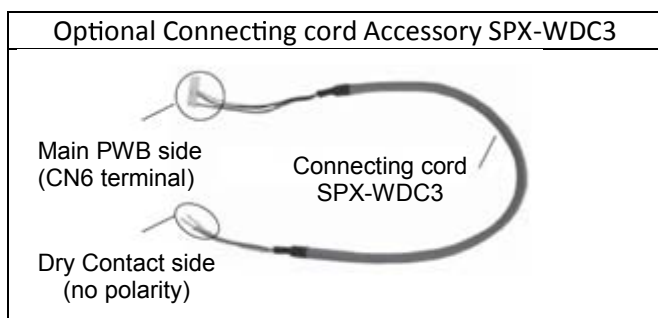

- Please decide A or B type of dry contact , you can use HHRC method and more details you can refer to Page 25.

Function Name	Value	Layer1	Layer2	Layer3
		Category	Function	Value
CardKey	Disable	1A	A0	01
	Card Key Input -A Enable			02
	Card Key Input -B Enable			03
	reserve			04-99

[1] CHECK DRY CONTACT OF CARD KEY UNIT

	AIR CONDITIONER Standby	AIR CONDITIONER Operating
CARD KEY (Door Switch)	REMOVE 	INSERT
Contact type A	OPEN 	CLOSE
Contact type B	CLOSE 	OPEN

After all connection has been done as below diagram, ON the breaker and push ON button of wireless remote controller or wired remote controller to operate the air conditioner unit.

- When the CARD KEY is in insert condition, the air conditioner operation is allowable by remote controller.
- When the dry contact switch on the Card Key Unit is open (refer to diagram below for contact type a), the unit stops to operate (it takes 10 seconds to stop the unit operation after the dry contact switch on the card key turns off) and vice versa.
- When the card key is removed from the Card Key Unit, the wireless remote controller cannot be used.
- When the card key is removed from the Card Key Unit, the wired remote controller LCD display is activated; however it has no control over the unit.
- The suitable accessory Connecting Cord (accessory code#: SPX-WDC3) need to be used to connect the Card Key Unit's dry contact switch to the connector on the control board of the indoor unit. Please refer to Table 1 to select suitable accessory code# for the concerning indoor model.

Example of wiring connection to Card Key Unit will be as below (reference only)

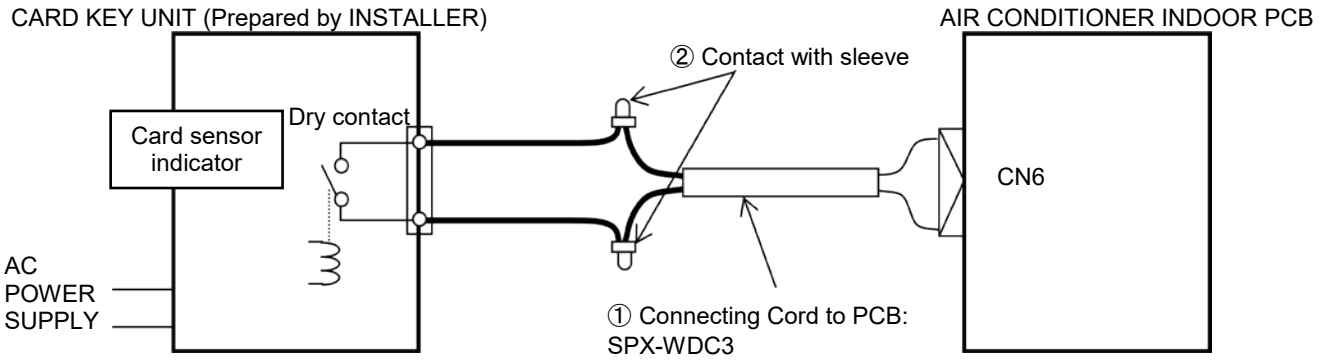

• CONNECTION EXAMPLE

i. HHRC for Dry Contact Type A

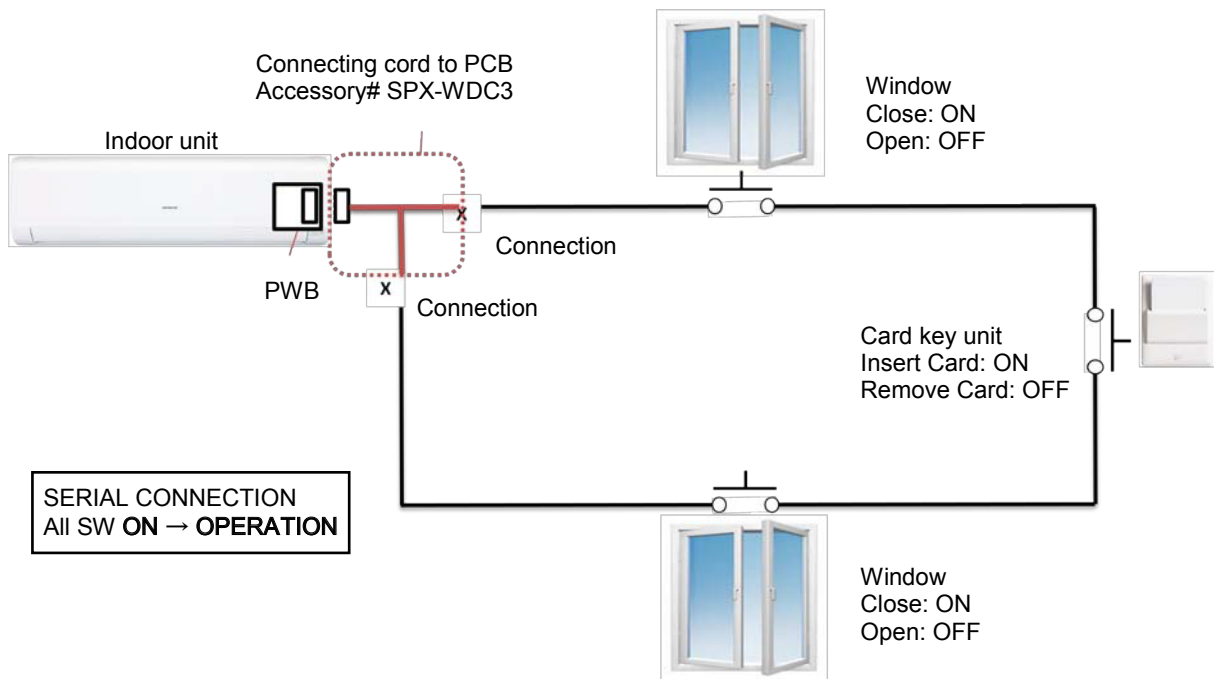

ii. HHRC for Dry Contact Type B

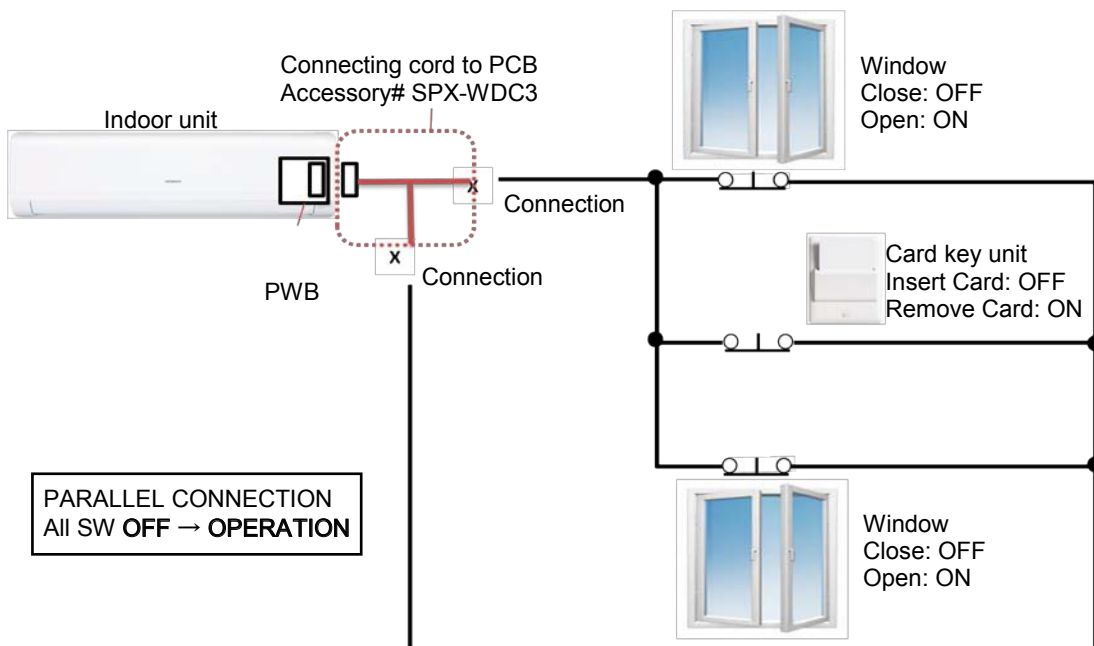

Please refer to the actual manual supplied with the optional connecting cords SPX-WDC3 for more details.

10.3 Wired remote control - SPX-URFG

The figure below shows all the functions for reference. The actual display during operation is different.

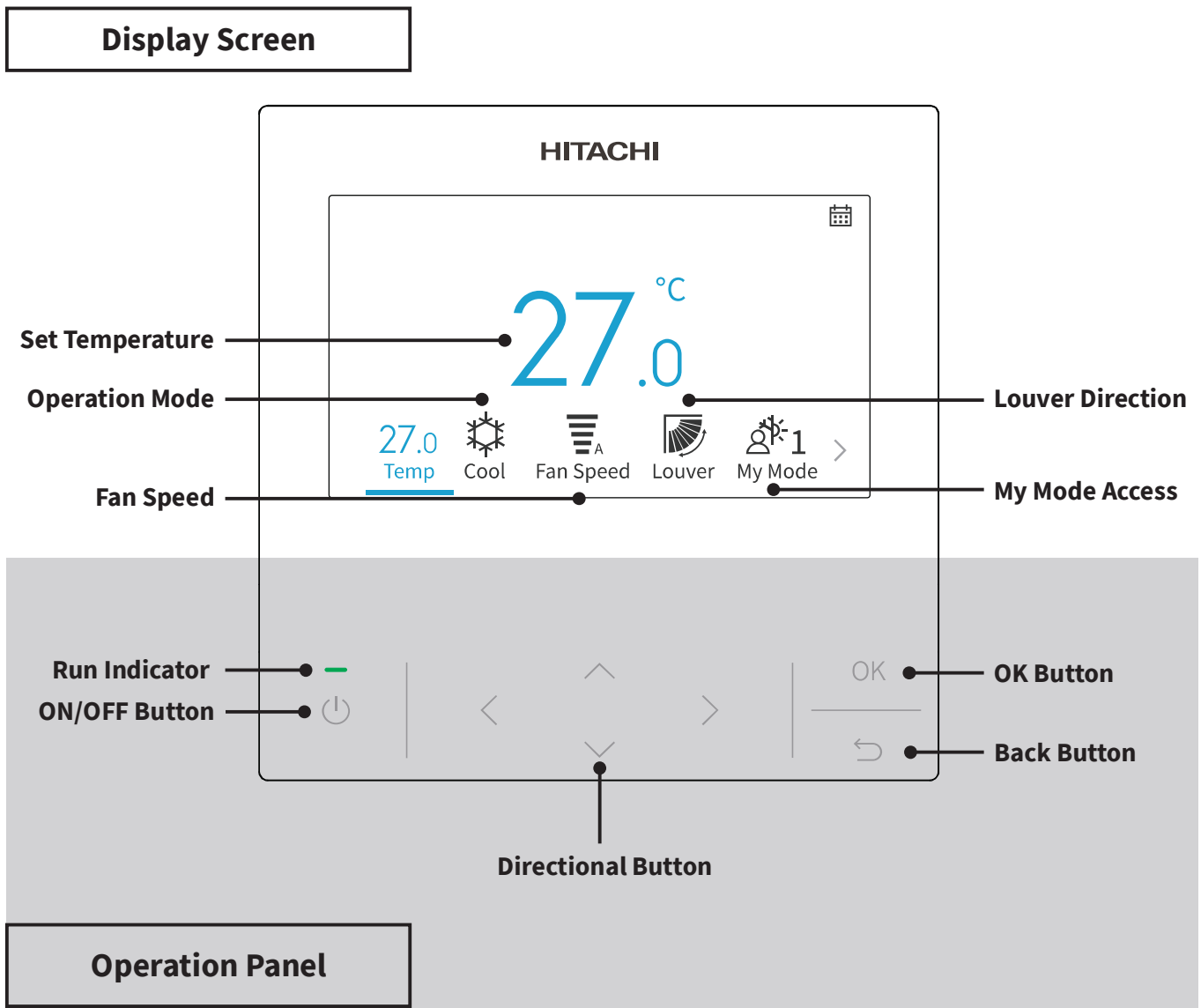

NOTES:

- If the screen is off or the backlight is dim, press any button to re-energise the screen.
- Make sure to press the buttons lightly with your fingertips.
- Do NOT press the buttons with any sharp objects as it may damage the button.

10.3.1 Service & Installation Screen

Service & Installation menu is protected by a password.

- Step1. Select "Service & Installation" on "Menu" screen and press "OK".

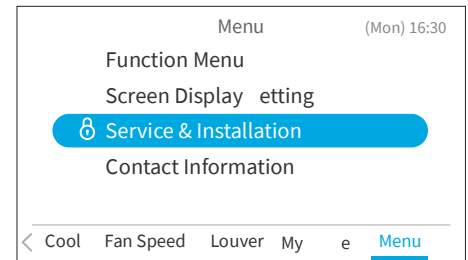

- Step2. Press "^", "v", "<", or ">" to input the password. Press ">" to select "OK" and press "OK" to enter Service & Installation menu screen.

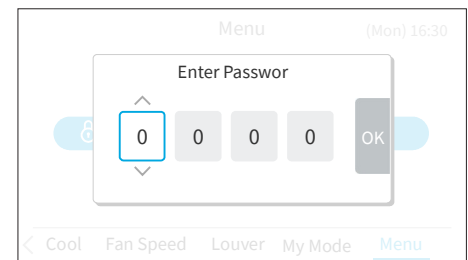

1. Password Setting

The default user password can be changed. If you forget the changed user password, a supervisor password can be used to reset the user password again. The supervisor password is "5567". The password input effective time can be set also.

If the password input effective time has been set, then the password is required to be entered only once during the password effective time.

1. Change Password

- Step1. Select "Password Setting" on Service & Installation screen and press "OK".

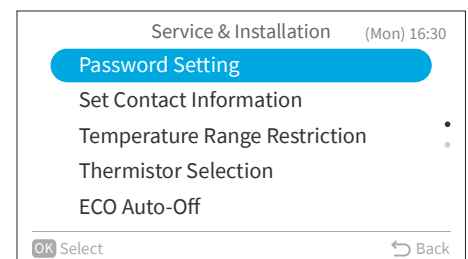

- Step2. Select "Change Password" and press "OK".

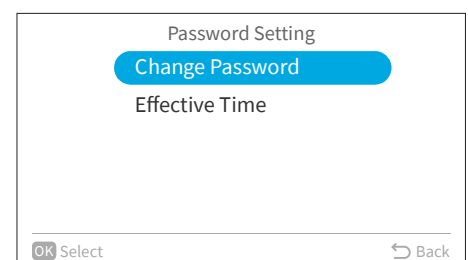

Step3. Press "^", "v", "<", or ">" to set the password, select "OK" and press "OK"

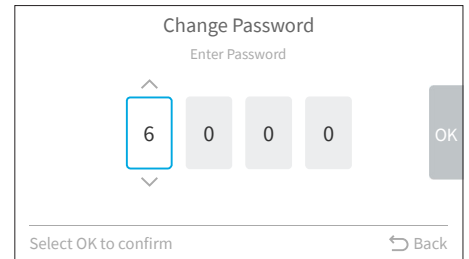

Step4. Press "<" or ">" to select "Save" and press "OK" to save password.

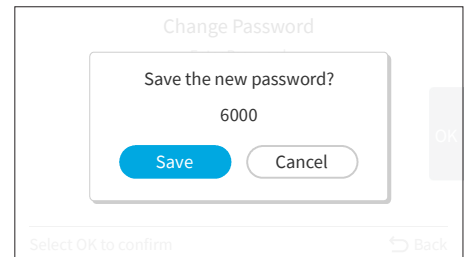

Press "OK", the new password is saved.

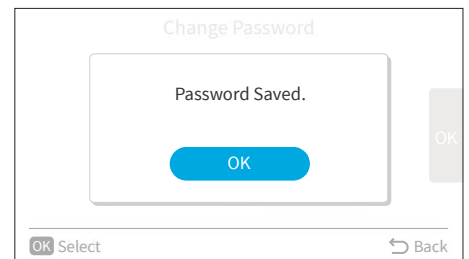

2. Set Password Input Effective Time

Step1. Select "Password Setting" on the Service & Installation screen and press "OK".

Step2. Select "Effective Time" and press "OK".

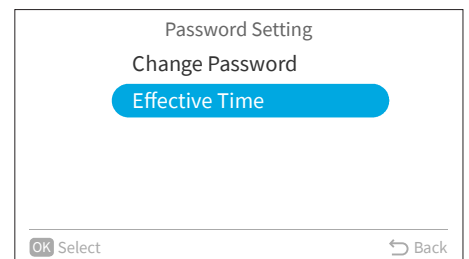

Step3. Press "^" or "v" to select the setting item and press "OK" to confirm the setting. The item changes as follows:
 "Everytime" ↔ "10 min" ↔ "30 min" ↔ "60 min" ↔ "120 min".
 Press "↩" and it returns to Step3.

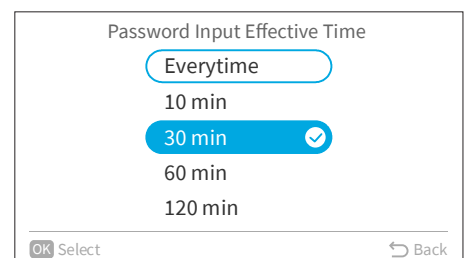

NOTES:

- In order to enhance the security protection, please be sure to change the default password.
- If you enter the wrong password more than 5 times, you will not be able to enter the password within 1 minute.
- The default password is "0000", and the supervisor code is "5567".
- If you forget the password, use the supervisor code to change the password.
- The supervisor code can't be changed.

2. Set Contact Information

Register a service contact (service address and service telephone number are recommended).

1. Register Contact Information

Step1. Select "Set Contact Information" on the Service & Installation screen and press "OK".

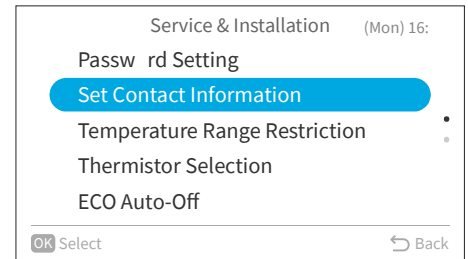

Step2. "Set Contact Information1" screen is displayed. Press "<" to move cursor to font type. Press "^" or "\<" to select the font type.

*Each time you want to change the font type, press "<" to move the cursor back to font type.

Step3. Press ">" to move cursor to the keypad. Press "^", "\<", "<", or ">" to select the font and press "OK" to register it. (Up to 60 characters can be used for each contact information.)

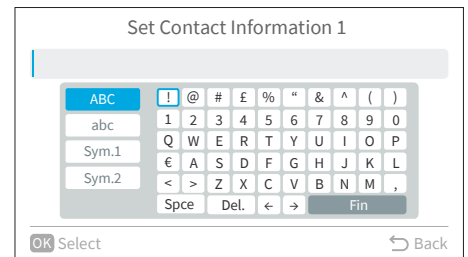

Step4. After all the characters have been set, select "Fin" and press "OK".

Step5. "Set Contact Information2" screen is displayed, repeat Step2, Step3 and Step4.

Step6. Select "Yes" and press "OK" to confirm the setting and Step1 is displayed. If "No" is selected, the screen returns to Step2.

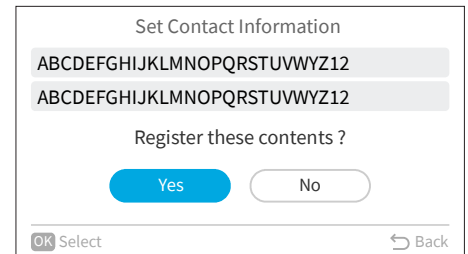

3. Temperature Range Restriction

The temperature range can be set by the wired remote controller.

1. Set Temperature Range

Step1. Select "Temperature Range Restriction" on the Service & Installation screen and press "OK".

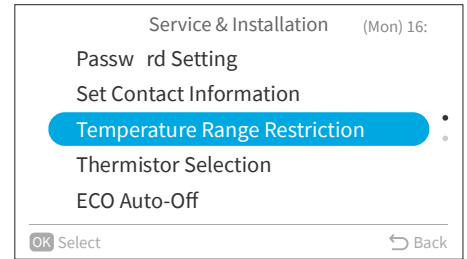

Step2. Select "Upper/Lower Limit for Cooling Operation"/"Upper/Lower Limit for Heating Operation"/ "Upper/Lower Limit for Auto mode" and press "OK"

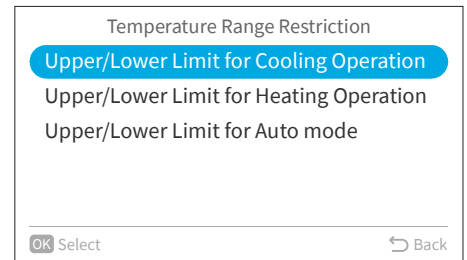

Step3. Press "<", ">" to select the setting limit, then press "^", "v" to change the temperature value.

Step4. After value setting, select "OK" and press "OK". Press "↶" to return to Step2.

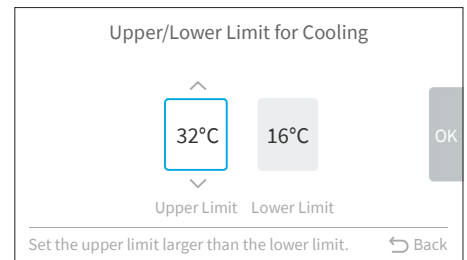

NOTE:

- Please make sure that the upper limit value is equal to or greater than the lower limit value.

4. Thermistor Selection

This function is to select wired remote controller thermistor or indoor unit thermistor as the room temperature.

Step1. Select "Thermistor Selection" on the Service & Installation screen and press "OK".

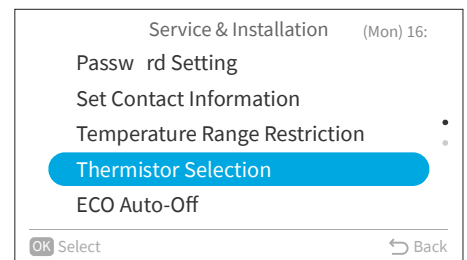

Step2. Select the desired item and press "OK".

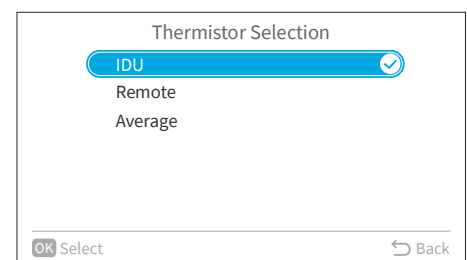

NOTE:

- If one of indoor unit or wired remote controller thermistor is broken, the other normal thermistor is selected automatically.

10.3.2 Service Settings

- The service setting items displayed in list depend on indoor unit model.
- When no operation for 2 hours on Service settings or sub settings screen, it returns to Home screen.
- When the air conditioner is turned on, service setting is disabled.
- For more information of service settings, please refer to service manual of the wired remote controller.

1. 1A: Installation

Step1. Select "Service Settings" on "Service & Installation" screen and press "OK".

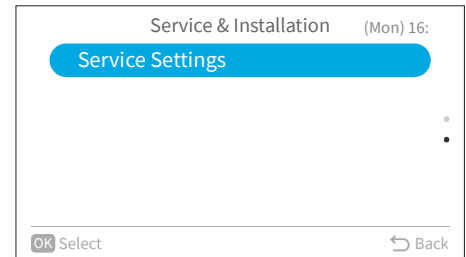

Step2. Select "1A: Installation" and press "OK"

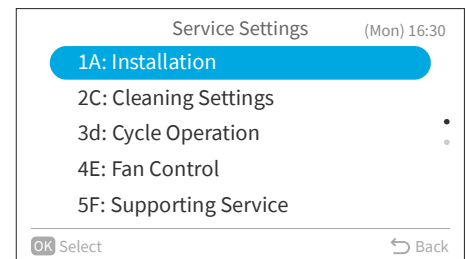

1.1 A0: Hotel Key Card Input contact

Step1. Select "A0: Hotel Key Card Input contact" and press "OK"

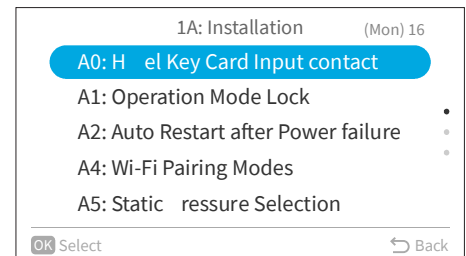

Step2. Press "^" or "v" to select the desired item and press "OK".

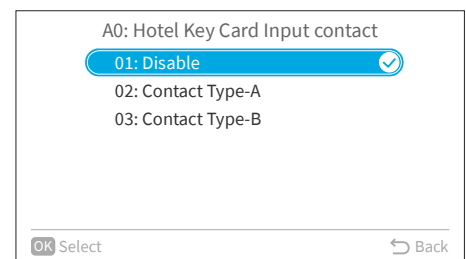

1.2 A1: Operation Mode Lock

Step1. Select "A1: Operation Mode Lock" and press "OK".

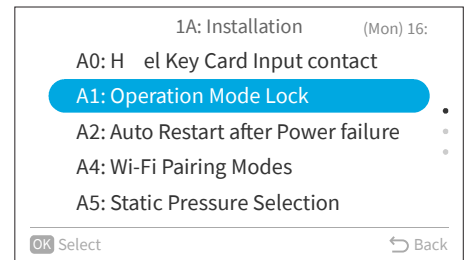

Step2. Press "▲" or "▼" to select the desired item and press "OK".

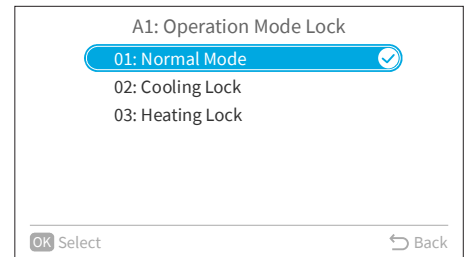

NOTE:

- The operation lock setting will remain unchanged after the unit is turned off.

1.3 A2: Auto Restart after Power failure

Step1. Select "A2: Auto Restart after Power failure" and press "OK".

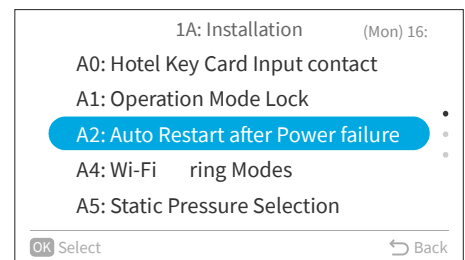

Step2. Press "▲" or "▼" to select the desired item and press "OK".

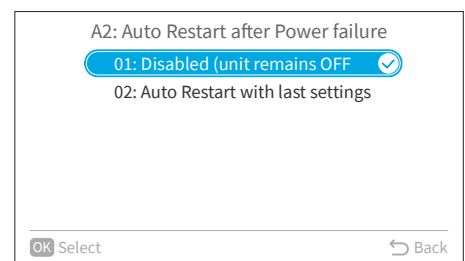

1.4 A4: Wi-Fi Pairing Mode

Step1. Select "A4: Wi-Fi Pairing Mode" and press "OK".

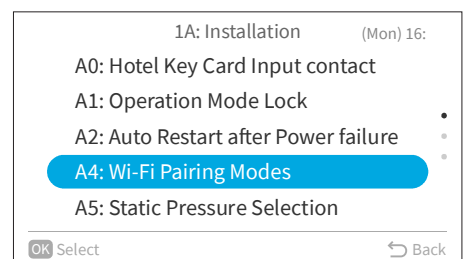

Step2. Press "▲" or "▼" to select the desired item and press "OK".

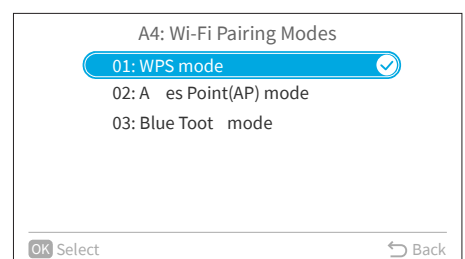

1.5 Reset 1A: Installation

Step1. Select "Reset 1A: Installation" and press "OK".

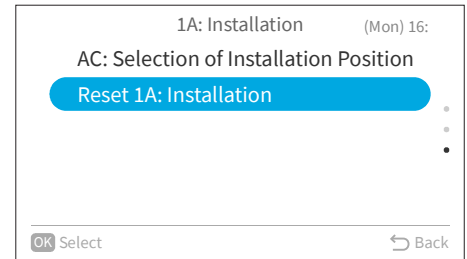

Step2. Select "Yes" and press "OK" to reset all settings of menu 1A.

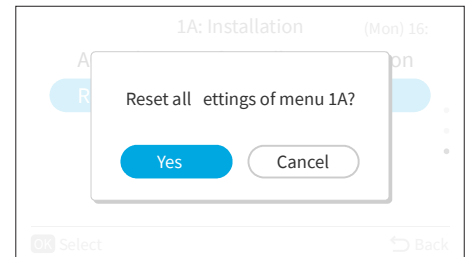

2. 2C: Cleaning Settings

Step1. Select "Service Settings" on "Service & Installation" screen and press "OK".

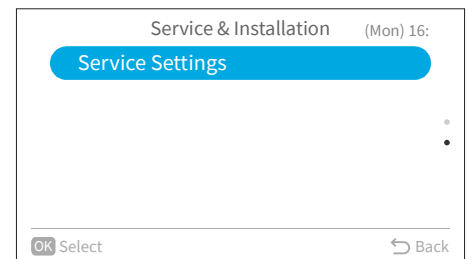

Step2. Select "2C: Cleaning Settings" and press "OK".

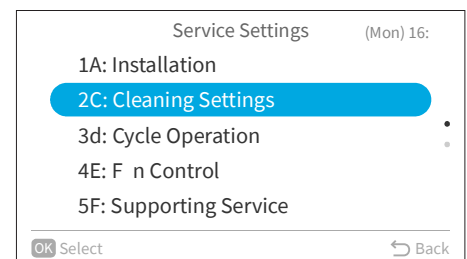

2.1 C1: Time for Filter Sign Display

Step1. Select "C1: Time for Filter Sign Display" and press "OK".

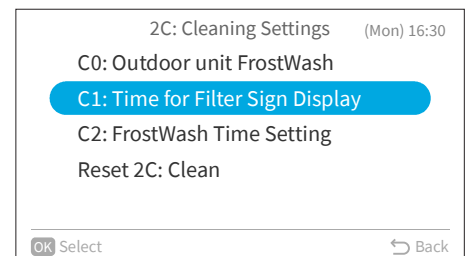

Step2. Press "^" or "v" to change the temperature, then press ">" to select "OK" and press "OK".

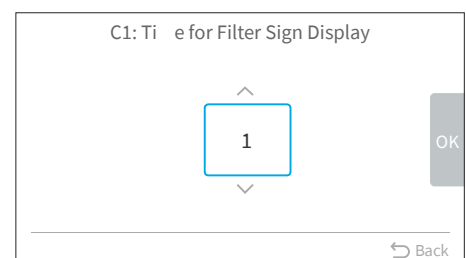

2.2 Reset 2C: Clean

Step1. Select "Reset 2C: Clean" and press "OK".

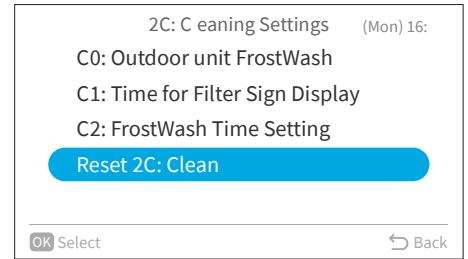

Step2. Select "Yes" and press "OK" to reset all settings of menu 2C.

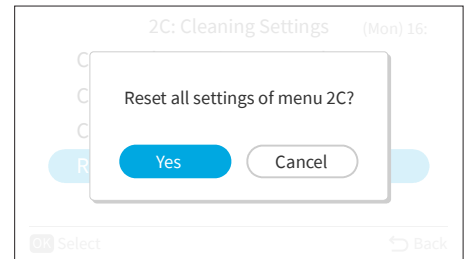

3. 3d: Cycle Operation

Step1. Select "Service Settings" on "Service & Installation" screen and press "OK".

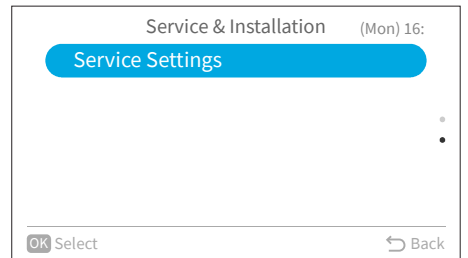

Step2. Select "3d: Cycle Operation" and press "OK".

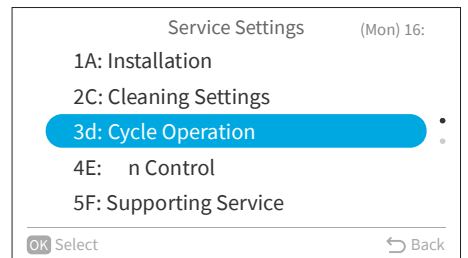

3.1 E0: Defrost Selection Function

Step1. Select "E0: Defrost Selection Function" and press "OK".

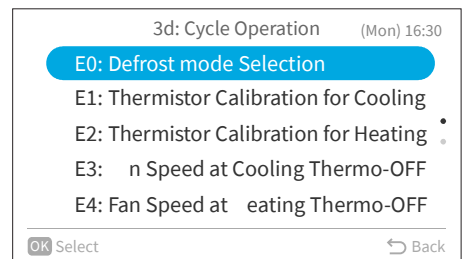

Step2. Press "^" or "v" to select the desired item and press "OK".

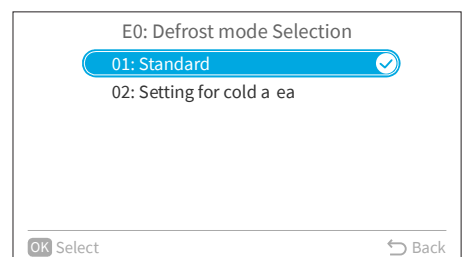

3.2 E1: Thermistor Calibration for Cooling

Step1. Select "E1: Thermistor Calibration for Cooling" and press "OK".

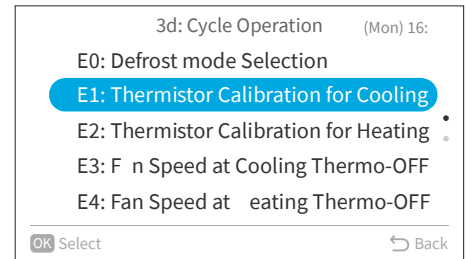

Step2. Press "^" or "v" to change the temperature, then press ">" to select "OK" and press "OK".

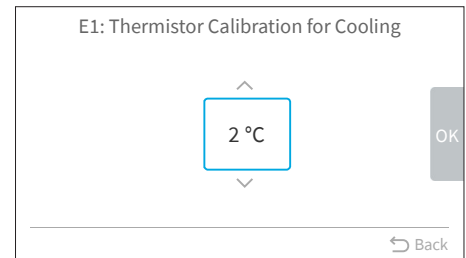

3.3 E2: Thermistor Calibration for Heating

Step1. Select "E2: Thermistor Calibration for Heating" and press "OK".

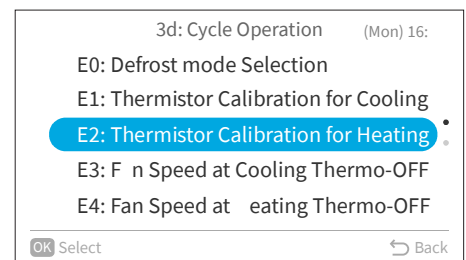

Step2. Press "^" or "v" to change the temperature, then press ">" to select "OK" and press "OK".

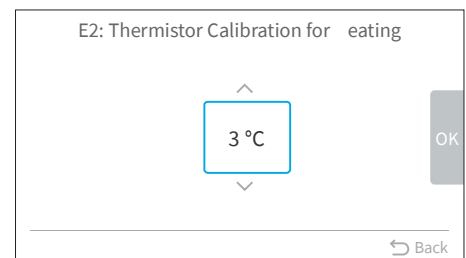

3.4 E3: Fan Speed at Cooling Thermo-OFF

Step1. Select "E3: Fan Speed at Cooling Thermo-OFF" and press "OK".

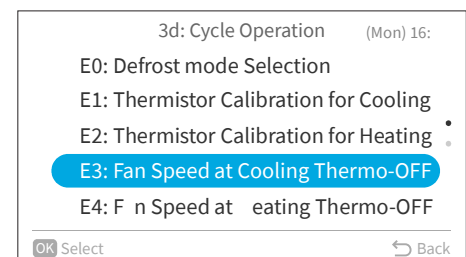

Step2. Press "^" or "v" to select the desired item and press "OK".

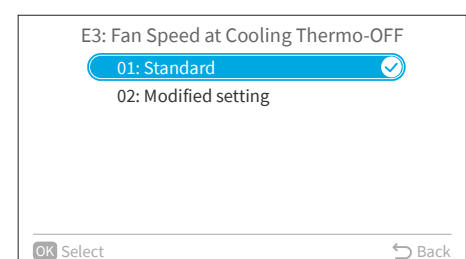

3.5 E4: Fan Speed at Heating Thermo-OFF

Step1. Select "E4: Fan Speed at Heating Thermo-OFF" and press "OK".

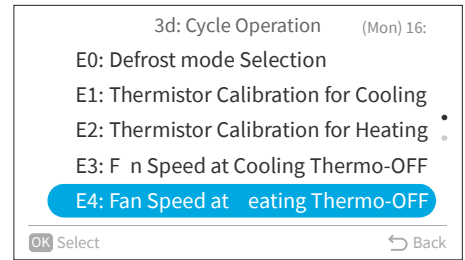

Step2. Press "^" or "v" to select the desired item and press "OK".

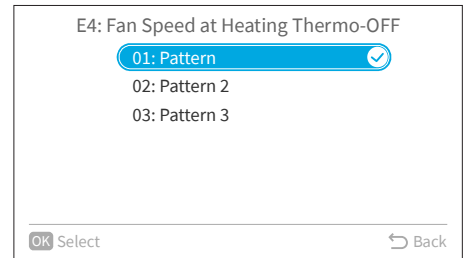

3.6 E5: Condensation Prevention Mode

Step1. Select "E5: Condensation Prevention Mode" and press "OK".

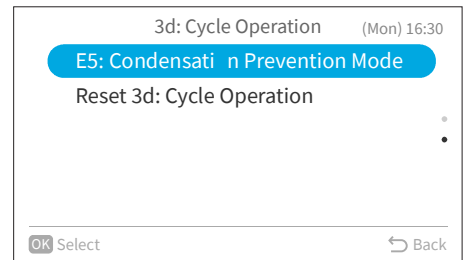

Step2. Press "^" or "v" to select the desired item and press "OK".

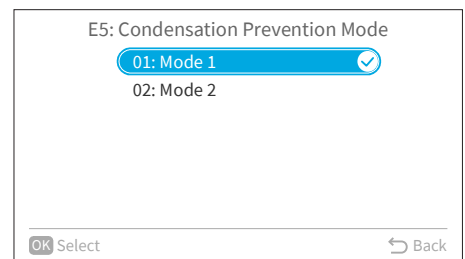

3.7 Reset 3d: Cycle Operation

Step1. Select "Reset 3d: Cycle Operation" and press "OK".

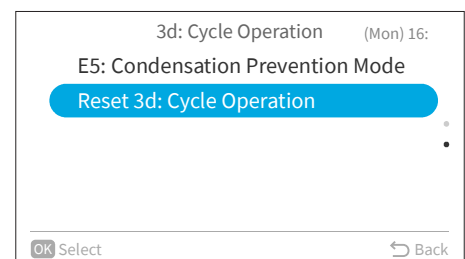

Step2. Select "Yes" and press "OK" to reset all settings of menu 3d.

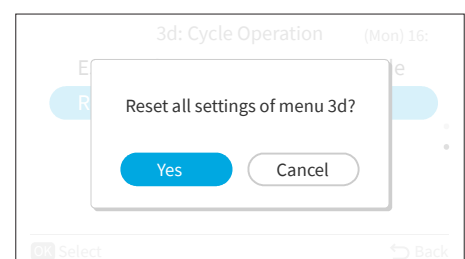

4. 5F: Supporting Service

Step1. Select "Service Settings" on "Service & Installation" screen and press "OK".

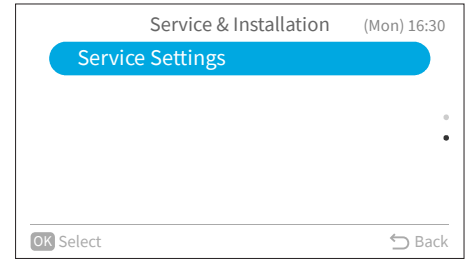

Step2. Select "5F: Supporting Service" and press "OK".

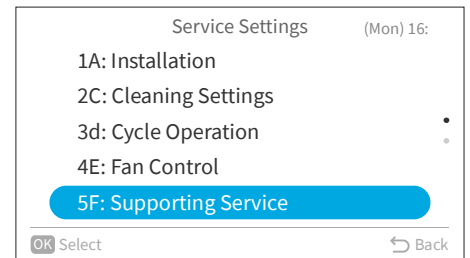

4.1 L1: Wi-Fi Forced Reset Count

Step1. Select "L1: Wi-Fi Forced Reset Count" and press "OK".

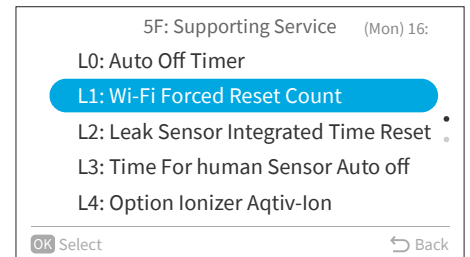

Step2. Press "^" or "v" to change the reset count, then press ">" to select "OK" and press "OK".

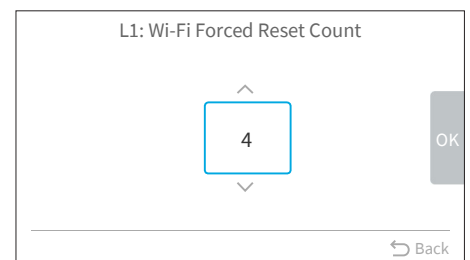

4.2 Reset 5F: Supporting Service

Step1. Select "Reset 5F: Supporting Service" and press "OK"

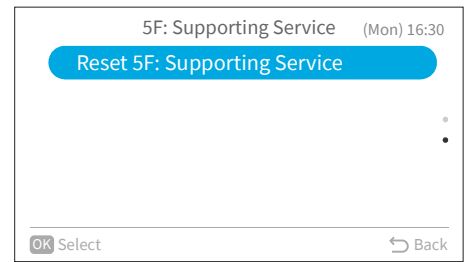

Step2. Select "Yes" and press "OK" to reset all settings of menu 5F.

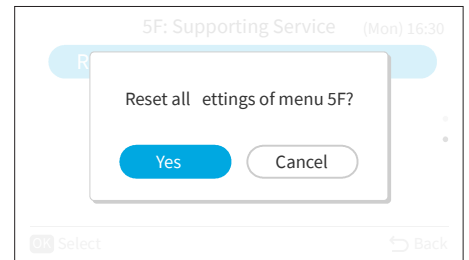

5. 7J: Diagnosis

Step1. Select "Service Settings" on "Service & Installation" screen and press "OK".

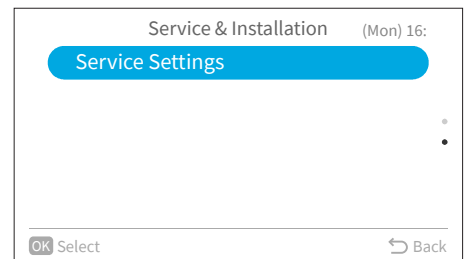

Step2. Select "7J: Diagnosis" and press "OK".

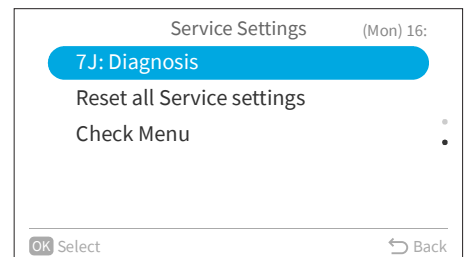

5.1 t0: Failure Indication

Step1. Select "t0: Failure Indication" and press "OK"

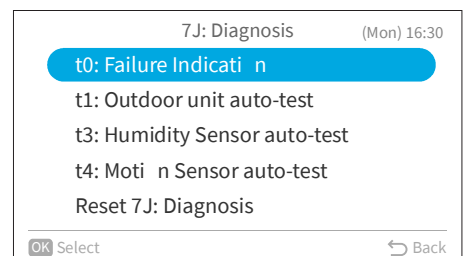

Step2. The failure indication screen is shown.

t0: Failure Indication	
Unit	Code
IDU	008
ODU	042
IDU	012
IDU	016
ODU	005

Back

NOTE:

- Second time to go to t0 after indoor unit and wired remote controller is powered on: Failure indication screen with a "Delete".

t0: Failure Indication	
Unit	Code
IDU	008
ODU	042
IDU	012
IDU	016
ODU	005

OK Delete ↶ Back

- Step3. Press "OK" and a reminder shows up. Select "Yes" and press "OK" to delete all failure logs.

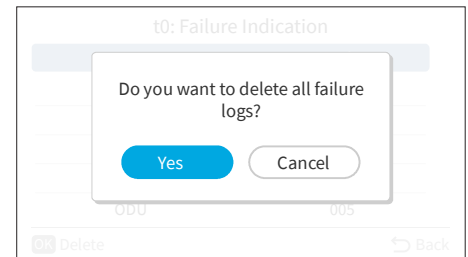

- Step4. After completing erasing, it turns to home screen.

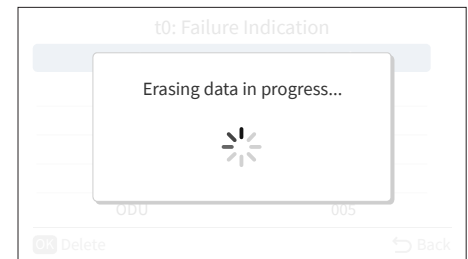

5.2 t1: Outdoor unit auto-test

- Step1. Select "t1: Outdoor unit auto-test" and press "OK".

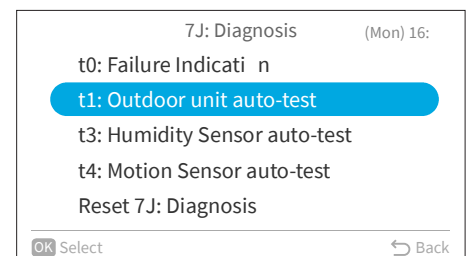

- Step2. Select "Yes" and press "OK" to request outdoor unit auto-test.

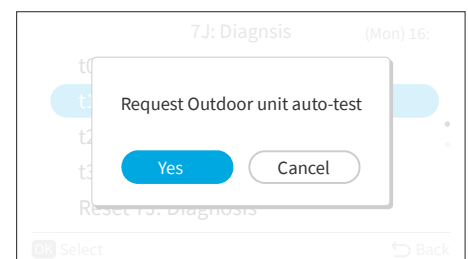

5.3 t3: Humidity Sensor auto-test

Step1. Select "t3: Humidity Sensor auto-test" and press "OK"

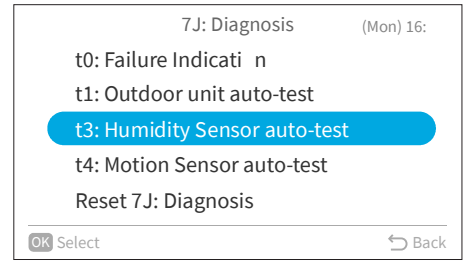

Step2. Select "Yes" and press "OK" to request humidity sensor auto-test.

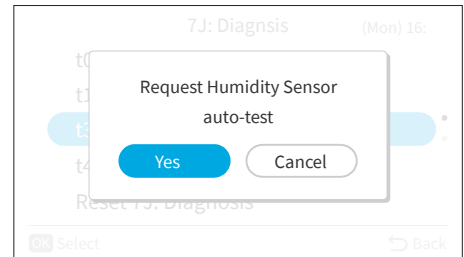

5.4 Reset 7J: Diagnosis

Step1. Select "Reset 7J: Diagnosis" and press "OK"

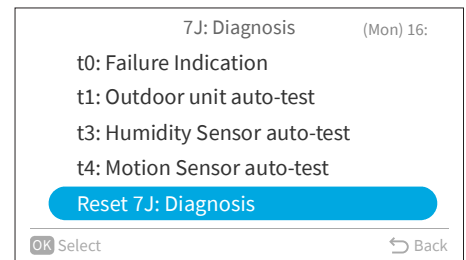

Step2. Select "Yes" and press "OK" to reset all settings of menu 7J.

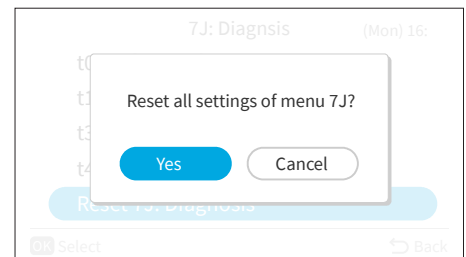

5.5 Reset All Service Settings

Step1. Select "Service Settings" on "Service & Installation" screen and press "OK".

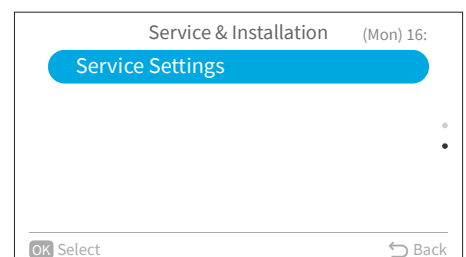

Step2. Select "Reset all Service settings" and press "OK".

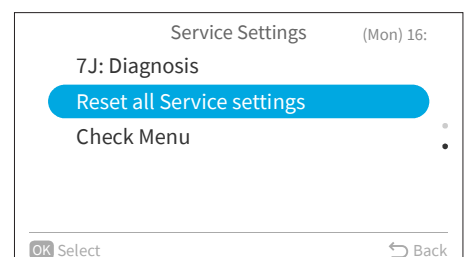

HITACHI

TC-ERP-Model

INDOOR

RAK-DJ18RHAE

RAK-DJ25RHAE

RAK-DJ35RHAE

RAK-DJ50RHAE

OUTDOOR

RAC-DJ18WHAE

RAC-DJ25WHAE

RAC-DJ35WHAE

RAC-DJ50WHAE