

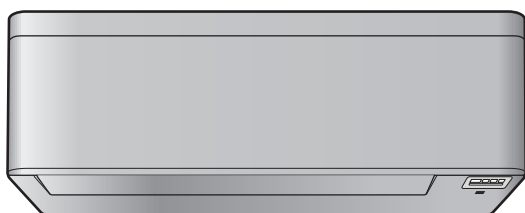

Installation manual

Daikin room air conditioner



**CTXA15C2V1BW
FTXA20C2V1BW
FTXA25C2V1BW
FTXA35C2V1BW
FTXA42C2V1BW
FTXA50C2V1BW**

**CTXA15C2V1BS
FTXA20C2V1BS
FTXA25C2V1BS
FTXA35C2V1BS
FTXA42C2V1BS
FTXA50C2V1BS**

**CTXA15C2V1BB
FTXA20C2V1BB
FTXA25C2V1BB
FTXA35C2V1BB
FTXA42C2V1BB
FTXA50C2V1BB**

Table of Contents

1 About the documentation 2
 1.1 About this document..... 2

2 Specific installer safety instructions 2

3 About the box 3
 3.1 Indoor unit 3
 3.1.1 To remove the accessories from the indoor unit 3

4 About the unit 4
 4.1 Operation range 4
 4.2 About the wireless LAN 4
 4.2.1 Precautions when using the wireless LAN 4
 4.2.2 Basic parameters 4

5 Unit installation 4
 5.1 Preparing the installation site 4
 5.1.1 Installation site requirements of the indoor unit 4
 5.2 Mounting the indoor unit 5
 5.2.1 To install the mounting plate 5
 5.2.2 To drill a wall hole 5
 5.2.3 To remove the pipe port cover 6
 5.3 Connecting the drain piping 6
 5.3.1 To connect the piping on right side, right-back, or right-bottom 6
 5.3.2 To connect the piping on left side, left-back, or left-bottom 6
 5.3.3 To check for water leaks 6

6 Piping installation 6
 6.1 Preparing refrigerant piping 6
 6.1.1 Refrigerant piping requirements 6
 6.1.2 Refrigerant piping insulation 7
 6.2 Connecting the refrigerant piping 7
 6.2.1 To connect the refrigerant piping to the indoor unit 7
 6.2.2 To check refrigerant piping joints for leaks after charging refrigerant 7

7 Electrical installation 7
 7.1 Specifications of standard wiring components 8
 7.2 To connect the electrical wiring to the indoor unit 8
 7.3 To connect optional accessories (wired user interface, central user interface, etc.) 8

8 Finishing the indoor unit installation 9
 8.1 To insulate the drain piping, refrigerant piping and interconnection cable 9
 8.2 To pass the pipes through the wall hole 9
 8.3 To fix the unit on the mounting plate 9

9 Configuration 9

10 Commissioning 10
 10.1 Checklist before commissioning 10
 10.2 To perform a test run 10
 10.2.1 To perform a test run using the wireless remote control 10

11 Disposal 10

12 Technical data 10
 12.1 Wiring diagram 10
 12.1.1 Unified wiring diagram legend 10

1 About the documentation

1.1 About this document

 **WARNING**
 Make sure installation, servicing, maintenance, repair and applied materials follow the instructions from Daikin (including all documents listed in “Documentation set”) and, in addition, comply with applicable legislation and are performed by qualified persons only. In Europe and areas where IEC standards apply, EN/IEC 60335-2-40 is the applicable standard.

 **INFORMATION**
 Make sure that the user has the printed documentation and ask him/her to keep it for future reference.

Target audience

Authorised installers

 **INFORMATION**
 This appliance is intended to be used by expert or trained users in shops, in light industry, and on farms, or for commercial and household use by lay persons.

Documentation set

This document is part of a documentation set. The complete set consists of:

- **General safety precautions:**
 - Safety instructions that you **MUST** read before installing
 - Format: Paper (in the box of the indoor unit)
- **Indoor unit installation manual:**
 - Installation instructions
 - Format: Paper (in the box of the indoor unit)
- **Installer reference guide:**
 - Preparation of the installation, good practices, reference data,...
 - Format: Digital files on <https://www.daikin.eu>. Use the search function  to find your model.

Latest revisions of the supplied documentation may be available on the regional Daikin website or via your dealer.

Scan the QR code below to find the full documentation set and more information about your product on Daikin website.



The original instructions are written in English. All other languages are translations of the original instructions.

Technical engineering data

- A **subset** of the latest technical data is available on the regional Daikin website (publicly accessible).
- The **full set** of latest technical data is available on the Daikin Business Portal (authentication required).

2 Specific installer safety instructions

Always observe the following safety instructions and regulations.

Unit installation (see "5 Unit installation" ▶ 4)



WARNING

Installation shall be done by an installer, the choice of materials and installation shall comply with the applicable legislation. In Europe, EN378 is the applicable standard.



WARNING

The appliance shall be stored so as to prevent mechanical damage and in a well-ventilated room without continuously operating ignition sources (e.g. open flames, an operating gas appliance, or an operating electric heater). The room size shall be as specified in the General safety precaution.



CAUTION

For walls containing a metal frame or a metal board, use a wall embedded pipe and wall cover in the feed-through hole to prevent possible heat, electrical shock, or fire.

Piping installation (see "6 Piping installation" ▶ 6)



A2L WARNING: MILDLY FLAMMABLE MATERIAL

The refrigerant inside this unit is mildly flammable.



CAUTION

Piping and joints of a split system shall be made with permanent joints when inside an occupied space except joints directly connecting the piping to the indoor units.



DANGER: RISK OF BURNING/SCALDING



CAUTION

- Incomplete flaring may cause refrigerant gas leakage.
- Do NOT re-use flares. Use new flares to prevent refrigerant gas leakage.
- Use flare nuts that are included with the unit. Using different flare nuts may cause refrigerant gas leakage.

Electrical installation (see "7 Electrical installation" ▶ 7)



DANGER: RISK OF ELECTROCUTION



WARNING

ALWAYS use multicore cable for power supply cables.



WARNING

- All wiring MUST be performed by an authorised electrician and MUST comply with the applicable national wiring regulation.
- Make electrical connections to the fixed wiring.
- All components procured on-site and all electrical construction MUST comply with the applicable legislation.



WARNING

- If the power supply has a missing or wrong N-phase, equipment might break down.
- Establish proper earthing. Do NOT earth the unit to a utility pipe, surge absorber, or telephone earth. Incomplete earthing may cause electrical shocks.
- Install the required fuses or circuit breakers.
- Secure the electrical wiring with cable ties so that the cables do NOT come in contact with sharp edges or piping, particularly on the high-pressure side.
- Do NOT use taped wires, extension cords, or connections from a star system. They can cause overheating, electrical shocks or fire.
- Do NOT install a phase advancing capacitor, because this unit is equipped with an inverter. A phase advancing capacitor will reduce performance and may cause accidents.



WARNING

Use an all-pole disconnection type breaker with at least 3 mm between the contact point gaps that provides full disconnection under overvoltage category III.



WARNING

If the supply cord is damaged, it MUST be replaced by the manufacturer, its service agent or similarly qualified persons in order to avoid a hazard.



WARNING

Do NOT connect the power supply to the indoor unit. This could result in electrical shock or fire.



WARNING

- Do NOT use locally purchased electrical parts inside the product.
- Do NOT branch the power supply for the drain pump, etc. from the terminal block. This could result in electrical shock or fire.



WARNING

Keep the interconnection wiring away from copper pipes without thermal insulation as such pipes will be very hot.

3 About the box

3.1 Indoor unit

3.1.1 To remove the accessories from the indoor unit

1 Remove:

- the accessory bag located at the bottom of the package,
- the mounting plate attached to the back of the indoor unit,
- the spare SSID sticker located on the front grille.

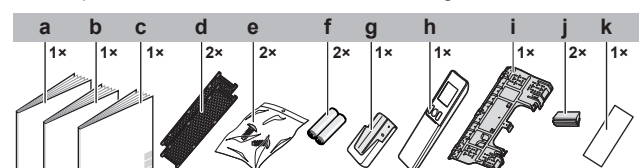

- a Installation manual
- b Operation manual
- c General safety precautions

4 About the unit

- d Titanium apatite deodorising filter and silver particle filter (Ag-ion filter)
- e Indoor unit fixing screw (M4×12L). Refer to "8.3 To fix the unit on the mounting plate" [p.9].
- f Dry battery AAA.LR03 (alkaline) for the wireless remote control
- g Wireless remote control (user interface) holder
- h Wireless remote control (user interface)
- i Mounting plate
- j Screw cover
- k Spare SSID sticker with release paper (attached to the unit)

- **Spare SSID sticker.** Do NOT throw away the spare sticker. Keep it in a safe place in case it is needed in future (e.g. in case the front grille was replaced attach it to the new front grille).

4 About the unit



WARNING: MILDLY FLAMMABLE MATERIAL

The refrigerant inside this unit is mildly flammable.

4.1 Operation range

Use the system in the following temperature and humidity ranges for safe and effective operation.

	Cooling and drying ^{(a)(b)}	Heating ^(a)
Outdoor temperature	-10~46°C DB	-15~24°C DB
Indoor temperature	18~32°C DB	10~30°C DB
Indoor humidity	≤80% ^(a)	—

^(a) A safety device might stop the operation of the system if the unit runs outside its operation range.

^(b) Condensation and water dripping might occur if the unit runs outside its operation range.

4.2 About the wireless LAN

For detailed specifications, installation instructions, setting methods, FAQ, declaration of conformity and the latest version of this manual, visit app.daikineurope.com.



INFORMATION: Declaration of conformity

- Daikin Industries Czech Republic s.r.o. declares that the radio equipment type inside of this unit is in compliance with Directive 2014/53/EU and S.I. 2017/1206: Radio Equipment Regulations 2017.
- This unit is considered as combined equipment according to the definition of Directive 2014/53/EU and S.I. 2017/1206: Radio Equipment Regulations 2017.

4.2.1 Precautions when using the wireless LAN

Do NOT use near:

- **Medical equipment.** E.g. persons using cardiac pacemakers or defibrillators. This product may cause electromagnetic interference.
- **Auto-control equipment.** E.g. automatic doors or fire alarm equipment. This product may cause faulty behaviour of the equipment.
- **Microwave oven.** It may affect wireless LAN communications.

4.2.2 Basic parameters

Parameter	Value
Frequency range	2400 MHz~2483.5 MHz
Radio protocol	IEEE 802.11b/g/n
Radio frequency channel	1~13
Output power	13 dBm
Effective radiated power	15 dBm (11b) / 14 dBm (11g) / 14 dBm (11n)
Power supply	DC 14 V / 100 mA

5 Unit installation



INFORMATION

If you are not sure how to open or close parts of the unit (front panel, electrical wiring box, front grille...) refer to the installer reference guide of the unit for opening and closing procedures. For location of the installer reference guide see "1.1 About this document" [p.2].



WARNING

Installation shall be done by an installer, the choice of materials and installation shall comply with the applicable legislation. In Europe, EN378 is the applicable standard.

5.1 Preparing the installation site



WARNING

The appliance shall be stored so as to prevent mechanical damage and in a well-ventilated room without continuously operating ignition sources (e.g. open flames, an operating gas appliance, or an operating electric heater). The room size shall be as specified in the General safety precaution.

5.1.1 Installation site requirements of the indoor unit



INFORMATION

The sound pressure level is less than 70 dBA.

- **Air flow.** Make sure nothing blocks the air flow.
- **Drainage.** Make sure condensation water can be evacuated properly.
- **Wall insulation.** When conditions in the wall exceed 30°C and a relative humidity of 80%, or when fresh air is inducted into the wall, then additional insulation is required (minimum 10 mm thickness, polyethylene foam).
- **Wall strength.** Check whether the wall or the floor is strong enough to support the weight of the unit. If there is a risk, reinforce the wall or the floor before installing the unit.
- **Spacing.** Install the unit at least 1.8 m from the floor and keep the following requirements in mind for distances from the walls and the ceiling:

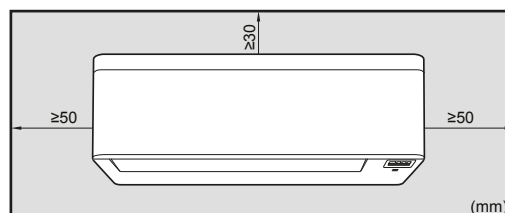

Note: Make sure that there are no obstacles within 500 mm under the infrared signal receiver. They may influence reception performance of the wireless remote control.

5.2 Mounting the indoor unit

5.2.1 To install the mounting plate

- 1 Install the mounting plate temporarily.
- 2 Level the mounting plate.
- 3 Mark the centres of the drilling points on the wall using a tape measure. Position the end of tape measure at symbol ">".
- 4 Finish the installation by securing the mounting plate on the wall using M4×25L screws (field supply).

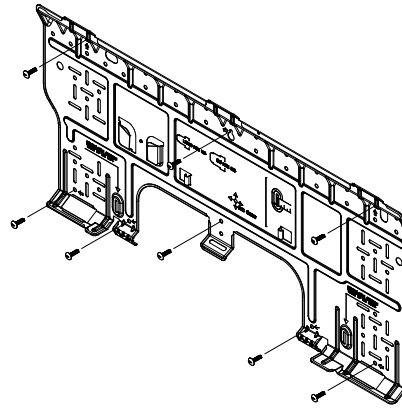

INFORMATION

The removed pipe port cover can be kept in the mounting plate pocket.

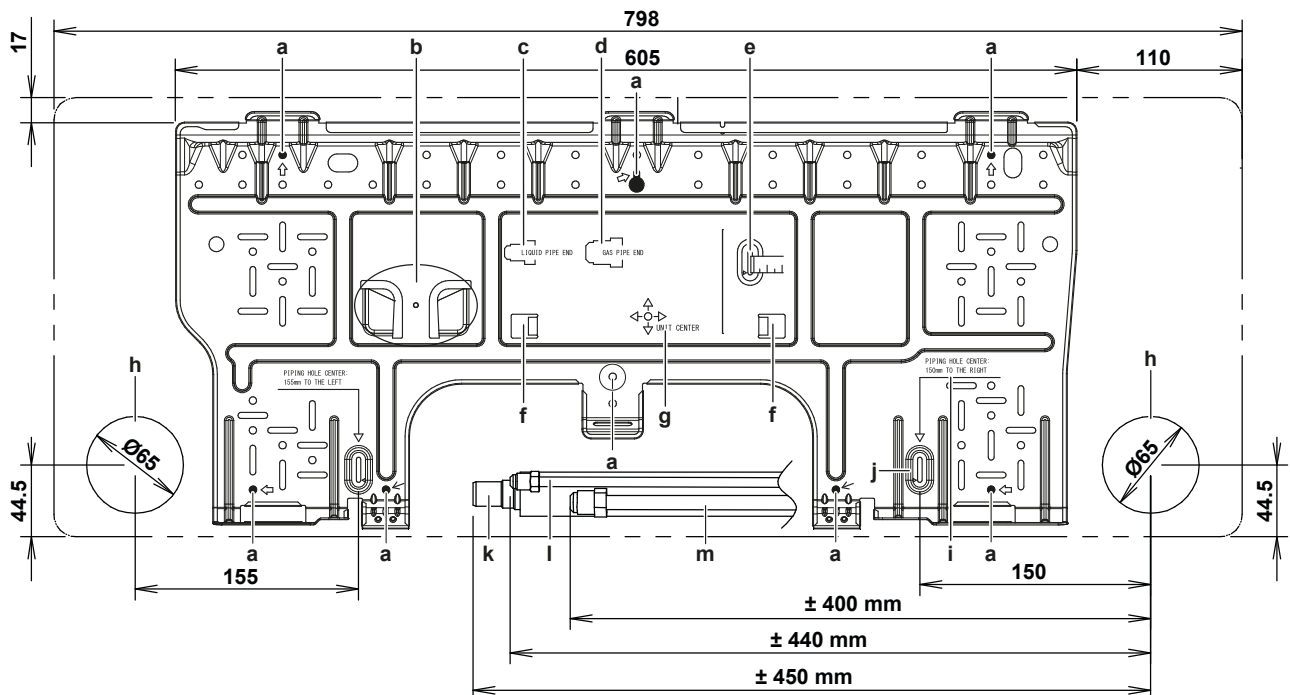

- a Recommended mounting plate fixing spots
- b Pocket for the pipe port cover
- c Liquid pipe end
- d Gas pipe end
- e Use tape measure as shown
- f Tabs for placing a spirit level
- g Unit center

- h Hole for embedded piping Ø65 mm
- i Value for tape measure
- j Position for tape measure at symbol ">"
- k Drain hose
- l Liquid pipe
- m Gas pipe

5.2.2 To drill a wall hole



CAUTION

For walls containing a metal frame or a metal board, use a wall embedded pipe and wall cover in the feed-through hole to prevent possible heat, electrical shock, or fire.



NOTICE

Be sure to seal the gaps around the pipes with sealing material (field supply), in order to prevent water leakage.

- 1 Bore a 65 mm large feed-through hole in the wall with a downward slope towards the outside.
- 2 Insert a wall embedded pipe into the hole.
- 3 Insert a wall cover into the wall pipe.

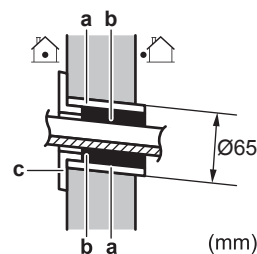

- a Wall embedded pipe
- b Putty
- c Wall hole cover

- 4 After completing wiring, refrigerant piping and drain piping, do NOT forget to seal the gap with putty.

6 Piping installation

5.2.3 To remove the pipe port cover

i INFORMATION

To connect the piping on right-side, right-bottom, left-side or left-bottom, the pipe port cover **MUST** be removed.

- 1 Cut off the pipe port cover from inside the front grille using a coping saw.

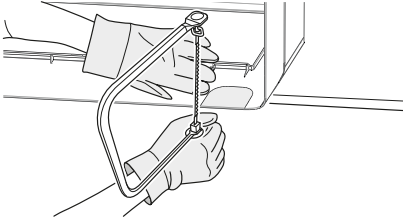

- 2 Remove any burrs along the cut section using a half round needle file.

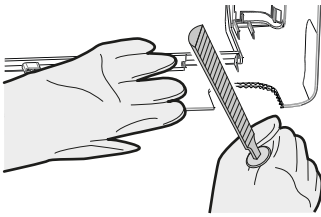

! NOTICE

Do **NOT** use nippers to remove the pipe port cover, as this would damage the front grille.

5.3 Connecting the drain piping

5.3.1 To connect the piping on right side, right-back, or right-bottom

i INFORMATION

The factory default is right-side piping. For left-side piping, remove the piping from the right side and install it on the left side.

- 1 Attach the drain hose with adhesive vinyl tape to the bottom of the refrigerant pipes.
- 2 Wrap the drain hose and the refrigerant pipes together using insulation tape.

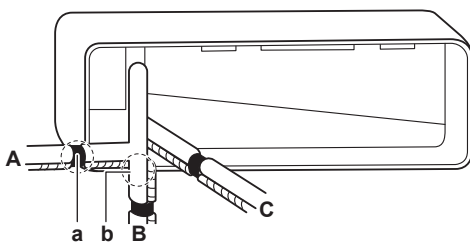

- A Right-side piping
- B Right-bottom piping
- C Right-back piping
- a Remove the pipe port cover here for right side piping
- b Remove the pipe port cover here for right-bottom piping

5.3.2 To connect the piping on left side, left-back, or left-bottom

i INFORMATION

The factory default is right-side piping. For left-side piping, remove the piping from the right side and install it on the left side.

- 1 Remove the insulation fixing screw on the right side and remove the drain hose.
- 2 Remove the drain plug on the left side and attach it to the right side.

! NOTICE

Do **NOT** apply lubricating oil (refrigerant oil) to the drain plug when inserting it. The drain plug may deteriorate and cause drain leakage from the plug.

- 3 Insert the drain hose on the left side and do not forget to tighten it with the fixing screw; otherwise water leakage may occur.

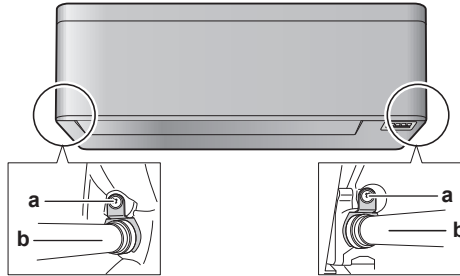

- a Insulation fixing screw
- b Drain hose

- 4 Attach the drain hose to the refrigerant piping bottom side using adhesive vinyl tape.

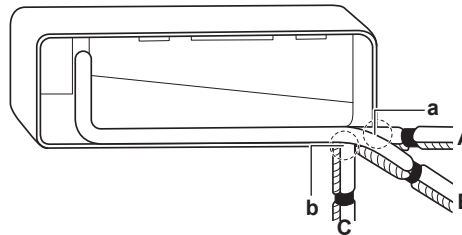

- A Left-side piping
- B Left-back piping
- C Left-bottom piping
- a Remove the pipe port cover here for left-side piping
- b Remove the pipe port cover here for left-bottom piping

5.3.3 To check for water leaks

- 1 Remove the air filters.
- 2 Gradually pour approximately 1 l of water in the drain pan, and check for water leaks.

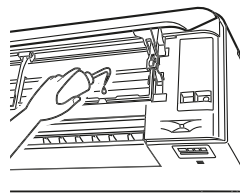

6 Piping installation

6.1 Preparing refrigerant piping

6.1.1 Refrigerant piping requirements

! CAUTION

Piping and joints of a split system shall be made with permanent joints when inside an occupied space except joints directly connecting the piping to the indoor units.



NOTICE

The piping and other pressure-containing parts shall be suitable for refrigerant. Use phosphoric acid deoxidised seamless copper for refrigerant piping.

- Foreign materials inside pipes (including oils for fabrication) must be ≤ 30 mg/10 m.

Refrigerant piping diameter

Use the same diameters as the connections on the outdoor units:

Class	Pipe outer diameter (mm)	
	Liquid pipe	Gas pipe
15~42	Ø6.4	Ø9.5
50	Ø6.4	Ø12.7

Refrigerant piping material

- Piping material:** phosphoric acid deoxidised seamless copper
- Flare connections:** Only use annealed material.
- Piping temper grade and thickness:**

Outer diameter (Ø)	Temper grade	Thickness (t) ^(a)	
6.4 mm (1/4")	Annealed (O)	≥ 0.8 mm	
9.5 mm (3/8")			
12.7 mm (1/2")			

^(a) Depending on the applicable legislation and the maximum working pressure of the unit (see "PS High" on the unit name plate), larger piping thickness might be required.

6.1.2 Refrigerant piping insulation

- Use polyethylene foam as insulation material:
 - with a heat transfer rate between 0.041 and 0.052 W/mK (0.035 and 0.045 kcal/mh°C)
 - with a heat resistance of at least 120°C
- Insulation thickness

Pipe outer diameter (Ø _p)	Insulation inner diameter (Ø _i)	Insulation thickness (t)
6.4 mm (1/4")	8~10 mm	≥ 10 mm
9.5 mm (3/8")	12~15 mm	≥ 13 mm
12.7 mm (1/2")	14~16 mm	≥ 13 mm

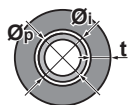

If the temperature is higher than 30°C and the humidity is higher than RH 80%, the thickness of the insulation materials should be at least 20 mm to prevent condensation on the surface of the insulation.

6.2 Connecting the refrigerant piping



DANGER: RISK OF BURNING/SCALDING

6.2.1 To connect the refrigerant piping to the indoor unit



A2L WARNING: MILDLY FLAMMABLE MATERIAL

The refrigerant inside this unit is mildly flammable.

- Pipe length.** Keep refrigerant piping as short as possible.

- Connect refrigerant piping to the unit using **flare connections**.

- Wrap the refrigerant piping connection using vinyl tape, overlapping at least half the width of the tape with each turn. Keep the slit of the heat insulation pipe cover up. Avoid wrapping the tape too tight.

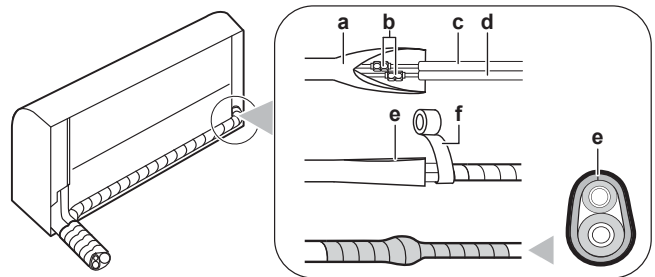

- a Heat insulation pipe cover (on the indoor unit side)
- b Flare connections
- c Liquid pipe (with insulation) (field supply)
- d Gas pipe (with insulation) (field supply)
- e Slit on heat insulation pipe cover facing up
- f Vinyl tape (field supply)

- Insulate** the refrigerant piping, interconnection cable and drain hose on the indoor unit: See "8.1 To insulate the drain piping, refrigerant piping and interconnection cable" [▶ 9].



NOTICE

Make sure to insulate all refrigerant piping. Any exposed piping might cause condensation.

6.2.2 To check refrigerant piping joints for leaks after charging refrigerant

- Perform the leak tests according to instructions in the outdoor unit installation manual.
- Charge refrigerant.
- Check for refrigerant leaks after charging (see below).

Tightness test of field-made refrigerant joints indoors

- Use a leakage test method with a minimum sensitivity of 5 g of refrigerant/year. Test leaks using a pressure of at least 0.25 times the maximum working pressure (see "PS High" on the unit nameplate).

If a leak is detected

- Recover the refrigerant, repair the joint, and repeat the test.

7 Electrical installation



DANGER: RISK OF ELECTROCUTION



WARNING

ALWAYS use multicore cable for power supply cables.



WARNING

If the supply cord is damaged, it MUST be replaced by the manufacturer, its service agent or similarly qualified persons in order to avoid a hazard.



WARNING

Do NOT connect the power supply to the indoor unit. This could result in electrical shock or fire.

7 Electrical installation



WARNING

- Do NOT use locally purchased electrical parts inside the product.
- Do NOT branch the power supply for the drain pump, etc. from the terminal block. This could result in electrical shock or fire.



WARNING

Keep the interconnection wiring away from copper pipes without thermal insulation as such pipes will be very hot.

7.1 Specifications of standard wiring components



NOTICE

We recommend using solid (single-core) wires. If stranded wires are used, slightly twist the strands to consolidate the end of the conductor for either direct use in the terminal clamp or insertion in a round crimp-style terminal. Details are described in "Guidelines when connecting the electrical wiring" in the installer reference guide.

Component		
Interconnection cable (indoor↔outdoor)	Voltage	220~240 V
	Wire size	Only use harmonized wire providing double insulation and suitable for applicable voltage 4-core cable Minimum 1.5 mm ²
Earth leakage circuit breaker / residual current circuit breaker	MUST comply with national wiring regulation	

7.2 To connect the electrical wiring to the indoor unit



WARNING

Provide adequate measures to prevent that the unit can be used as a shelter by small animals. Small animals that make contact with electrical parts can cause malfunctions, smoke or fire.



NOTICE

- Keep the power line and transmission line apart from each other. Transmission wiring and power supply wiring may cross, but may NOT run parallel.
- In order to avoid any electrical interference, the distance between both wirings should ALWAYS be at least 50 mm.

Electrical work should be carried out in accordance with the installation manual and the national electrical wiring rules or code of practice.

- Set the indoor unit on the mounting plate hooks. Use the "△" marks as a guide.

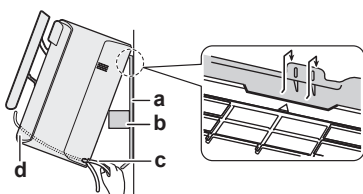

a Mounting plate (accessory)

- b Piece of packing material
- c Interconnection cable
- d Wire guide



INFORMATION

Support the unit using a piece of packing material.

Example:

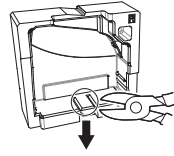

- Open the front panel, and then the service cover. Refer to the Installer reference guide for opening procedure. For location of the installer reference guide refer to "1 About the documentation" [▶ 2].
- Pass the interconnection cable from the outdoor unit through the feed-through wall hole, through the back of the indoor unit and through the front side.

Note: In case the interconnection cable was stripped in advance, cover the ends with insulating tape.

- Bend the end of the cable up.

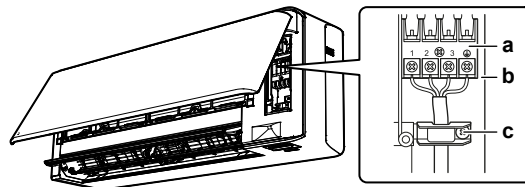

- a Terminal block
- b Electrical component block
- c Cable clamp

- Strip the wire ends approximately 15 mm.
- Match wire colours with terminal numbers on the indoor unit terminal blocks and firmly screw the wires to the corresponding terminals.
- Connect the earth wire to the corresponding terminal.
- Firmly fix the wires with the terminal screws.
- Pull the wires to make sure that they are securely attached, then retain the wires with the wire retainer.
- Shape the wires so that the service cover fits securely, then close the service cover.

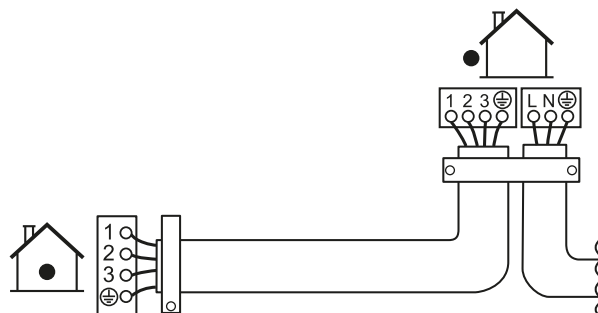

7.3 To connect optional accessories (wired user interface, central user interface, etc.)

- Remove the electrical wiring box cover (if needed, refer to the Installer reference guide to opening procedure)
- Attach the connection cable to the S21 connector and pull the wire harness as shown in the following figure.

8 Finishing the indoor unit installation

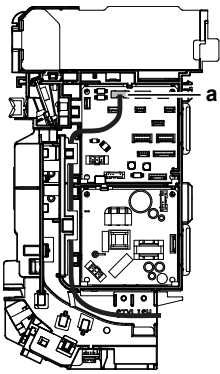

a S21 connector

- Put the electrical wiring box cover back and pull the wire harness around it as shown in the figure above.

8 Finishing the indoor unit installation

8.1 To insulate the drain piping, refrigerant piping and interconnection cable

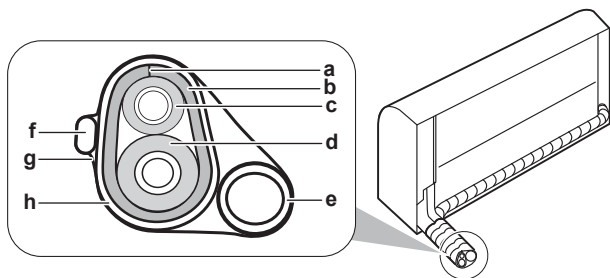

- a Slit
- b Heat insulation pipe cover
- c Liquid pipe
- d Gas pipe
- e Drain pipe
- f Interconnection wire
- g Insulation tape
- h Vinyl tape

- After the drain piping, refrigerant piping and the electrical wiring are finished. Wrap refrigerant piping, interconnection cable and drain hose together using insulation tape. Overlap at least half the width of the tape with each turn.

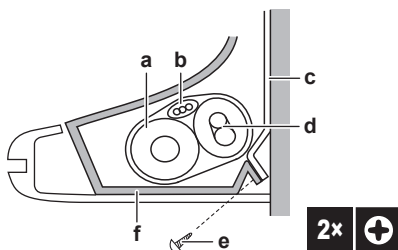

- a Drain hose
- b Interconnection cable
- c Mounting plate (accessory)
- d Refrigerant piping
- e Indoor unit fixing screw M4x12L (accessory)
- f Bottom frame

8.2 To pass the pipes through the wall hole

- Shape the refrigerant pipes along the pipe path marking on the mounting plate.

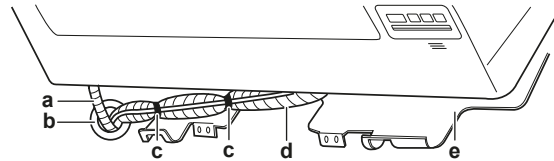

- a Drain hose
- b Caulk this hole with putty or caulking material
- c Adhesive vinyl tape
- d Insulation tape
- e Mounting plate (accessory)



NOTICE

- Do NOT bend refrigerant pipes.
- Do NOT push the refrigerant pipes onto the bottom frame or the front grille.

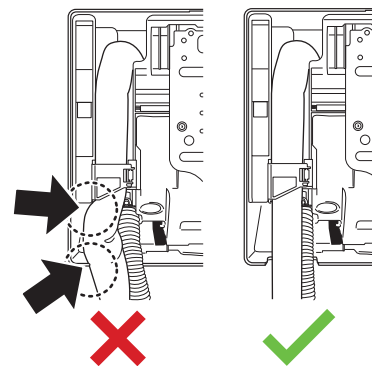

- Pass the drain hose and refrigerant piping through the wall hole and seal the gap with a putty.

8.3 To fix the unit on the mounting plate

- Set the indoor unit on the mounting plate hooks. Use the "△" marks as a guide.

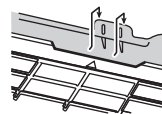

- Press the bottom frame of the unit with both hands to set it on the bottom hooks of the mounting plate. Make sure that the wires do NOT get squeezed anywhere.

Note: Take care that the interconnection cable does NOT get caught in the indoor unit.

- Press the bottom edge of the indoor unit with both hands until it is firmly caught by the mounting plate hooks.
- Secure the indoor unit to the mounting plate using 2 indoor unit fixing screws M4x12L (accessory).

9 Configuration



INFORMATION

In case 2 indoor units are installed in 1 room, set different addresses for 2 user interfaces. For procedure refer to the installer reference guide, for location see "1.1 About this document" [p. 2].

10 Commissioning

NOTICE

General commissioning checklist. Next to the commissioning instructions in this chapter, a general commissioning checklist is also available on the Daikin Business Portal (authentication required).

The general commissioning checklist is complementary to the instructions in this chapter and can be used as a guideline and reporting template during commissioning and hand-over to the user.

NOTICE

ALWAYS operate the unit with thermistors and/or pressure sensors/switches. If NOT, burning of the compressor might be the result.

10.1 Checklist before commissioning

- 1 After the installation of the unit, check the items listed below.
- 2 Close the unit.
- 3 Power up the unit.

<input type="checkbox"/>	You read the complete installation instructions, as described in the installer reference guide .
<input type="checkbox"/>	The indoor units are properly mounted.
<input type="checkbox"/>	The outdoor unit is properly mounted.
<input type="checkbox"/>	Air inlet/outlet Check that the air inlet and outlet of the unit is NOT obstructed by paper sheets, cardboard, or any other material.
<input type="checkbox"/>	There are NO missing phases or reversed phases .
<input type="checkbox"/>	The refrigerant pipes (gas and liquid) are thermally insulated.
<input type="checkbox"/>	Drainage Make sure drainage flows smoothly. Possible consequence: Condensate water might drip.
<input type="checkbox"/>	The system is properly earthed and the earth terminals are tightened.
<input type="checkbox"/>	The fuses or locally installed protection devices are installed according to this document, and have NOT been bypassed.
<input type="checkbox"/>	The power supply voltage matches the voltage on the identification label of the unit.
<input type="checkbox"/>	The specified wires are used for the interconnection cable .
<input type="checkbox"/>	The indoor unit receives the signals of the user interface .
<input type="checkbox"/>	There are NO loose connections or damaged electrical components in the switch box.
<input type="checkbox"/>	The insulation resistance of the compressor is OK.
<input type="checkbox"/>	There are NO damaged components or squeezed pipes on the inside of the indoor and outdoor units.
<input type="checkbox"/>	There are NO refrigerant leaks .
<input type="checkbox"/>	The correct pipe size is installed and the pipes are properly insulated.
<input type="checkbox"/>	The stop valves (gas and liquid) on the outdoor unit are fully open.

10.2 To perform a test run







Prerequisite: Power supply MUST be in the specified range.

Prerequisite: Test run may be performed in cooling or heating mode.

Prerequisite: Test run should be performed in accordance with the operation manual of the indoor unit to make sure that all functions and parts are working properly.

- 1 In cooling mode, select the lowest programmable temperature. In heating mode, select the highest programmable temperature. Test run can be disabled if necessary.
- 2 When the test run is finished, set the temperature to a normal level. In cooling mode: 26~28°C, in heating mode: 20~24°C.
- 3 The system stops operating 3 minutes after the unit is turned OFF.

10.2.1 To perform a test run using the wireless remote control

- 1 Press  to switch the system on.
- 2 Press  and  simultaneously.
- 3 Press , select  and press .

Result: Test run operation will stop automatically after about 30 minutes.

- 4 To stop operation sooner, press .

11 Disposal

NOTICE

Do NOT try to dismantle the system yourself: dismantling of the system, treatment of the refrigerant, oil and other parts MUST comply with applicable legislation. Units MUST be treated at a specialised treatment facility for reuse, recycling and recovery.

12 Technical data





- A **subset** of the latest technical data is available on the regional Daikin website (publicly accessible).
- The **full set** of latest technical data is available on the Daikin Business Portal (authentication required).

12.1 Wiring diagram

The wiring diagram is delivered with the unit, located on the inner right side of the indoor unit front grille.

12.1.1 Unified wiring diagram legend

For applied parts and numbering, refer to the wiring diagram on the unit. Part numbering is by Arabic numbers in ascending order for each part and is represented in the overview below by "*" in the part code.

Symbol	Meaning	Symbol	Meaning
	Circuit breaker		Protective earth
			
	Connection		Protective earth (screw)

Symbol	Meaning	Symbol	Meaning
	Connector		Rectifier
	Earth		Relay connector
	Field wiring		Short-circuit connector
	Fuse		Terminal
	Indoor unit		Terminal strip
	Outdoor unit		Wire clamp
	Residual current device		Heater

Symbol	Colour	Symbol	Colour
BLK	Black	ORG	Orange
BLU	Blue	PNK	Pink
BRN	Brown	PRP, PPL	Purple
GRN	Green	RED	Red
GRY	Grey	WHT	White
SKY BLU	Sky blue	YLW	Yellow

Symbol	Meaning
A*P	Printed circuit board
BS*	Pushbutton ON/OFF, operation switch
BZ, H*O	Buzzer
C*	Capacitor
AC*, CN*, E*, HA*, HE*, HL*, HN*, HR*, MR*_A, MR*_B, S*, U, V, W, X*A, K*R_*, NE	Connection, connector
D*, V*D	Diode
DB*	Diode bridge
DS*	DIP switch
E*H	Heater
FU*, F*U, (for characteristics, refer to PCB inside your unit)	Fuse
FG*	Connector (frame ground)
H*	Harness
H*P, LED*, V*L	Pilot lamp, light emitting diode
HAP	Light emitting diode (service monitor green)
HIGH VOLTAGE	High voltage
IES	Intelligent eye sensor
IPM*	Intelligent power module
K*R, KCR, KFR, KHuR, K*M	Magnetic relay
L	Live
L*	Coil
L*R	Reactor
M*	Stepper motor
M*C	Compressor motor
M*F	Fan motor
M*P	Drain pump motor
M*S	Swing motor
MR*, MRCW*, MRM*, MRN*	Magnetic relay
N	Neutral
n=*, N=*	Number of passes through ferrite core
PAM	Pulse-amplitude modulation

Symbol	Meaning
PCB*	Printed circuit board
PM*	Power module
PS	Switching power supply
PTC*	PTC thermistor
Q*	Insulated gate bipolar transistor (IGBT)
Q*C	Circuit breaker
Q*DI, KLM	Earth leak circuit breaker
Q*L	Overload protector
Q*M	Thermo switch
Q*R	Residual current device
R*	Resistor
R*T	Thermistor
RC	Receiver
S*C	Limit switch
S*L	Float switch
S*NG	Refrigerant leak detector
S*NPH	Pressure sensor (high)
S*NPL	Pressure sensor (low)
S*PH, HPS*	Pressure switch (high)
S*PL	Pressure switch (low)
S*T	Thermostat
S*RH	Humidity sensor
S*W, SW*	Operation switch
SA*, F1S	Surge arrester
SR*, WLU	Signal receiver
SS*	Selector switch
SHEET METAL	Terminal strip fixed plate
T*R	Transformer
TC, TRC	Transmitter
V*, R*V	Varistor
V*R	Diode bridge, Insulated-gate bipolar transistor (IGBT) power module
WRC	Wireless remote controller
X*	Terminal
X*M	Terminal strip (block)
Y*E	Electronic expansion valve coil
Y*R, Y*S	Reversing solenoid valve coil
Z*C	Ferrite core
ZF, Z*F	Noise filter



Copyright 2023 Daikin

DAIKIN INDUSTRIES CZECH REPUBLIC s.r.o.

U Nové Hospody 1/1155, 301 00 Plzeň Skvrňany, Czech Republic

DAIKIN EUROPE N.V.

Zandvoordestraat 300, B-8400 Oostende, Belgium

3P697375-6B 2023.05